



# **FILOVIRUS HAEMORRHAGIC FEVER**

## **GUIDELINE**

**Médecins Sans Frontières**

**2008**

**Esther Sterk, MD**

**L003HEFG03E**

# Filovirus Haemorrhagic Fever Guideline 2008

## Foreword

The Filovirus Haemorrhagic Fever (FHF) Guideline gives a short explanation and overview of all intervention strategy components needed during a Médecins sans Frontières (MSF) intervention in Marburg and Ebola viral haemorrhagic fever outbreaks.

It is a practical summary of the **MSF Ebola & Marburg Outbreak Control Guidance Manual, 2007 version 2.0**, with the ‘lessons learned’ added from the Ebola outbreaks in 2007 in the Democratic Republic of Congo and Uganda.

It is useful as preparation for MSF expatriates and national staff going to work in an intervention, while the Guidance Manual will remain the exclusive ‘Guidance’ to provide all detailed information needed to implement and continue the intervention strategies and activities.

Any remarks or comments are welcome to be able to update, adapt and improve the guidelines according to the needs and evolution of Ebola and Marburg interventions.

Comments can be addressed to:

Medicos sin Fronteras – Medical Director of the Medical Department  
Nou de la Rambla, 26 - 08001 Barcelona – Spain

## Contributors

Matthias Borchert, Carol Coeur, Claire Dorion, Christian Fabiansen, Laurence Flevaud, Michel van Herp, Benjamin Jeffs, Barbara Barcelo Monserrat, Jean-Jaques Myembe, Pedro Pablo Palma, Paul Roddy, Olimpia de la Rosa, Armand Sprecher, David Weatherill,

# Table of contents

<b>Foreword</b>	1
<b>Table of contents</b>	2
<b>Abbreviations</b>	8
<b>Definitions</b>	9
<b>CHAPTER 1. FEATURES OF FHF OUTBREAKS</b>	10
1. Epidemiology	10
History	
Infectious agent	10
Reservoir	12
2. Transmission, period of communicability, carriers and immunity	12
Modes of transmission	12
Period of communicability	13
Carriers	13
Immunity	13
3. Sensitivity of the virus	14
4. Clinical features of a FHF infection	14
Incubation period	14
Pathophysiology	14
Clinical symptoms	15
Possible predictors of death	15
Convalescent patients	15
5. Treatment and vaccine	16
6. Impact of a FHF outbreak	16
Key points	16
<b>CHAPTER 2. OUTBREAK INVESTIGATION, SAMPLE TAKING AND CASE DEFINITIONS</b>	17
A. MSF will be the first to do the assessment and to take samples of suspected cases for confirmation	17
1. Triggering the alert	17
2. Exploratory mission	18
3. Confirmation of diagnosis by laboratory testing	18
Identify a laboratory	18
Patient selection for samples	18
Sample taking	18
Quantity of samples to be taken	19
Conservation per transport medium	19
Available laboratory tests	19
Triple layer packaging	19
Transport of the sample	20
Laboratory confirmation	20

4. Case definitions	20
5. Describing the situation	20
Collection of data: number of cases and deaths and demographic data	21
Organizing data by person, time and place	21
Analyzing data: weekly incidence rate, attack rate and case fatality rate	21
6. Assessing the response capacity of the health system	22
7. Identifying priority areas for intervention	22
8. Reporting and formulating recommendations for action	22
B. A FHF outbreak is ongoing and interventions have started. There is a suspect outside the epidemic area and MSF is asked to investigate the case.	23
Key points	23
<b>CHAPTER 3. INTERVENTION STRATEGIES</b>	24
1. Objectives	24
2. Coordination, collaboration and Task Force/Crisis Committee	24
Main activities of the Task Force	25
3. The Top Ten Priorities when starting an intervention	25
Key points	25
<b>CHAPTER 4. SET UP, ORGANIZATION AND ACTIVITIES IN ISOLATION FACILITIES</b>	26
1. Community acceptance of the Marburg/Ebola unit	26
Activities to increase community acceptance and collaboration	26
2. Set up and organization of the Marburg/Ebola unit	27
Location	27
Buildings/Structures	28
Risk zones:	
A. High-risk zone	28
B. Low-risk zone	28
C. No-risk zone	28
Activities and facilities in the different risk zones:	29
A. High-risk zone	29
B. Low-risk zone	29
C. No-risk zone	29
Fencing	31
Lay-out	31
Entrance/exit points and disinfection	31
Changing rooms	31
Staff, patients and material circuits	32
Footbaths	32
Store, stock and supply	32
3. Barrier nursing and infection control	33
Personal Protective Equipment (PPE)	33
PPE for visitors and patient's attendants	33
Dressing and undressing procedures	33
4. Infection control measures	35
Disinfection	35
Disinfection of patient's excreta, urine, vomits or blood	35
Water: quantity, quality and storage	35
Sanitation: latrines, bathing and laundry	36

Waste management	37
5. Home Based Support and Risk Reduction	37
HBSSR procedures	38
Key points	38
<b>CHAPTER 5. PATIENT CARE</b>	39
1. Medical staff for Marburg/Ebola unit	39
2. Admission	39
3. Laboratory tests	40
4. Medical care	40
Invasive procedures	41
Hydration:	
A. Oral hydration	41
B. IV hydration	41
Symptomatic care:	
A. Anti-pyretics	42
B. Pain control	42
C. Nausea, vomiting and dyspepsia	42
D. Anxiety	42
E. Agitation and confusion	42
Presumptive treatment:	
A. Broad spectrum antibiotics	43
B. Anti-malarials	43
Supplementation	44
Nutritional support:	
Procedures to provide food	44
Type of food	44
5. Nursing care	44
6. Psychological support	45
7. Children in the Marburg/Ebola unit	45
Mothers with breast-feeding children	45
8. Maternities and FHF	46
9. Discharge	46
Discharge criteria:	
Clinical criteria	46
Laboratory support	46
Discharge procedures:	
Disinfection	46
Solidarity kit	47
Accompany patient to his/her home	47
Supportive treatment and follow up	47
10. Patient care in the Home Based Care Support and Risk Reduction	47
Laboratory test	47
Medical file	47
Treatment	47
Admission and discharge criteria	48
Psychological support	48
Key points	48
<b>CHAPTER 6. SURVEILLANCE SYSTEM FOR CASE DETECTION AND SAFE TRANSPORTATION</b>	49
1. Contact tracing and follow up	49
Activities	49
2. Rumor checking	50
Activities	50

3. Ambulance service and safe transport	51
Activities	51
Procedures when transporting to Marburg/Ebola unit	51
Spraying of the house	52
Arrival at the Marburg/Ebola unit	52
Disinfection of the car	52
4. National health structures	52
Free access to health care	53
Restriction of at-risk procedures	53
Triage	53
Triage in health posts and health centers	53
Triage in hospitals	53
Triage procedures	54
Active search for admitted patients in the ward	54
Mortality review in the health facilities	54
5. Protection during activities outside the Marburg/Ebola unit	55
6. Dressing and undressing during activities outside the Marburg/Ebola unit	56
Procedures	56
Key points	56
<b>CHAPTER 7. SPRAYING AND SAFE BURIAL PROCEDURES</b>	<b>57</b>
1. Home spraying	57
2. Spraying of the Marburg/Ebola ward after a discharge, referral or a death	57
3. Safe burial procedures	58
Family involvement	58
4. Community deaths	58
Key points	58
<b>CHAPTER 8. LOGISTICS</b>	<b>59</b>
1. Emergency preparedness	59
2. Security	59
3. MSF Cars & Communication	59
4. Roads	59
5. The Base	60
6. Staff housing	60
7. Marburg/Ebola unit	60
8. Security Stock	61
9. The Kits	61
The MSF Standard Filovirus Haemorrhagic Fever Kit	61
Module 7 – Sampling & Assessment	62
Local Purchase	62
Solidarity Kit	62
Health Center Kit	62
Key points	62
<b>CHAPTER 9. HEALTH PROMOTION AND PSYCHOSOCIAL SUPPORT</b>	<b>63</b>
1. Health promotion and social, cultural and anthropological issues	63
Health promotion messages	63
Phase A. An initial rapid dissemination of information to the affected population	63

Phase B. In-depth cultural, social and anthropological information and analysis	64
Changing risk behavior	64
Burials and spraying of the patient's houses	64
2. Psychological and social support	64
Main objectives	64
Key points	64
<b>CHAPTER 10. MONITORING EPIDEMIOLOGICAL DATA</b>	65
1. Epidemiological form	65
2. Describing the situation	65
3. Clinical data	66
4. Epidemiological database	66
5. Epidemiological links and existing transmission chains	66
Key points	67
<b>CHAPTER 11. HUMAN RESOURCES, EXPATRIATE LIFE AND ACCIDENTAL EXPOSURE</b>	68
1. Expatriate staff and expatriate life	68
Before arriving in the field	68
Arrival in the field:	
Health responsible in the field	69
Instructions about measures to prevent diseases	69
Instructions about measures to prevent FHF diseases	69
During the mission:	
Living conditions	70
Rest and length of stay for staff working in outbreak control	70
Stress during a FHF outbreak: stressors, stress manifestations and ways to manage stress	70
2. Accidental exposure	71
Definition of exposure	71
Actions to be taken on the spot	71
Degrees of risk	72
Evacuation	73
3. After the mission	74
Normal life	74
Falling sick in incubation period after returning from the field	74
4. National staff	74
Recruitment	74
Training, safety, supervision and psychological support	74
Evacuation	75
Key points	75
<b>CHAPTER 12. THE END OF THE EPIDEMIC</b>	76
1. When to declare the end of the outbreak	76
2. End of MSF intervention	76
3. Closing down the Marburg/Ebola unit	76
4. FHF preparedness for future outbreaks	76
Key points	77

## **ANNEXES**

Annex 1.	Module 7 - Sampling and Assessment	78
Annex 2.	Authorized Filovirus testing Centers and WHO contact information	81
Annex 3.A	Case definitions and their use	82
Annex 3.B	Suggested case definitions	83
Annex 4.	Sample information and conservation per transport medium	85
Annex 5.	Laboratory tests	86
Annex 6.	Sample collection: Transportation & IATA Regulations	88
Annex 7.	Site assessment form for Health Centers	90
Annex 8.	Standard for providing samples in filovirus outbreaks with laboratory in the country	92
Annex 9.	Examples of lay out of Marburg/Ebola unit with different risk zones	94
Annex 10.	Example of Plan of Changing Rooms	96
Annex 11.	Dressing and undressing protocols	97
Annex 12.	Preparation of chlorine solutions	102
Annex 13.	Cleaning and disinfection of Protective Equipment	104
Annex 14.	Waste management: waste definitions, collection, transport and disposal	105
Annex 15.	Caregiver task instructions HBSRR and HBSRR kit	106
Annex 16.	Information for patients, discharged patients and relatives	109
Annex 17.	List for patient items provided at admission	110
Annex 18.	Examples of medical and epidemiological forms	111
	18.1 Triage form	111
	18.2 Medical admission and epidemiological form	112
	18.3 Observation Sheet	116
	18.4 Contact tracing form	120
Annex 19.	Solidarity Kit	121
Annex 20.	Supplies for Rumor Checking team	122
Annex 21.	Supplies for Ambulance teams	123
Annex 22.	Supplies for Spraying teams	124
Annex 23.	Supplies for Burial teams	125
Annex 24.	Procedures to clean the Marburg/Ebola unit after a death	126
Annex 25.	Procedures for house disinfection	127
Annex 26.	Guidelines for safe burial practices	128
Annex 27.	Treatment of facilities and equipment when closing the Marburg/Ebola unit	130
Annex 28.	Suggested changes in the Haemorrhagic Fever Kit	132

<b>LITERATURE</b>	133
-------------------	-----

<b>BIBLIOGRAPHY</b>	133
---------------------	-----



## **ABBREVIATIONS**

CDC:	Center for Disease Control and Prevention
ELISA:	Enzyme-Linked-Immunosorbent Assay
FHF:	Filovirus Haemorrhagic Fever
IgM:	Immune globulin M
IgG:	Immune globulin G
IM:	Intra muscular
IV:	Intra venous
MOF:	Multiple Organ Failure
MoH:	Ministry of Health
MSF:	Medecins Sans Frontieres
NGO:	Non-Governmental Organization
NSAID:	Non-steroid anti-inflammatory drug
PCR:	Polymerase Chain Reaction
PPE:	Personal Protective Equipment
PO:	Per Os/Oral
PRN:	Pro Re Nata = when necessary
OD:	Once daily
RT:	Room temperature
TDS:	Ter in die = Three times a day
UNICEF:	United Nations Children's Fund
VHF:	Viral Haemorrhagic Fever
WHO:	World Health Organization

## DEFINITIONS

Aerosol:	A fine mist or spray that contains minute particles.
Antibody:	Type of protein in the blood that produces immunity against microorganisms or their toxins.
Antigen:	A molecule or substance that is recognized by the immune system, which triggers an immune response, such as the release of antibodies.
Arthralgia:	Joint pain.
Asthenia:	Severe weakness.
Case definition:	Criteria for deciding whether a person has a particular disease.
Carrier:	A person or animal that harbors a specific infectious agent without visible symptoms of the disease. A carrier acts as a potential source of infection.
Dysphagia:	Painful swallowing.
Haematemesis:	Vomiting of blood.
Haemoptysis:	Coughing of blood.
Host:	An organism in which a parasite lives and by which it is nourished.
Incubation period:	Period that the patient is infected with the virus, but is still asymptomatic and not contagious yet.
Nosocomial infection:	An infection acquired at a hospital or other healthcare facility.
Oedema:	An accumulation of an excessive amount of watery fluid in cells and tissues of the body.
Orchitis:	Inflammation of the testes.
Photophobia:	Painful oversensitivity to light.
Reservoir:	Any person, animal, anthropoid, plant, or substance which can harbor infection and hence act as a source of disease outbreak.
Tachypnoea:	Fast breathing.
Triage:	A system of assessing and sorting patients according to the likelihood of a specific disease or the severity of their illness, to aid in referral to appropriate isolation options and treatment.
Uveitis:	Inflammation within the eyeball.

# Chapter 1. Features of Filovirus Haemorrhagic Fever outbreaks

## 1. Epidemiology

### History

In 1967 laboratory personnel in the city Marburg, Germany, fell sick and several died after working with monkeys imported from Uganda. The virus identified causing the disease, was named after the town where the outbreak occurred.

In 1976 several people died in South-Sudan and in a bordering region in North Zaire (currently referred to as the Democratic Republic of the Congo) near the river Ebola. The virus identified was given the name Ebola due to its proximity to the river.

Since the discovery of the 2 viruses more outbreaks of Ebola and Marburg have been recognized in and around the Congo basin in central Africa: Gabon, Democratic Republic of the Congo, Republic of the Congo-Brazzaville, South-Sudan, Uganda and Angola. Sometimes there are only a few isolated cases, but larger epidemics can occur after amplification in health structures and can spread quickly. For an overview of all known Marburg and Ebola outbreaks until date see Tables 2 and 3.

### Infectious agent

The Ebola virus and the Marburg virus together form the family of Filoviridae. The Filoviruses are thread-like RNA viruses that cause haemorrhagic fever.

The Filoviruses cause severe disease in humans and non-human primates (gorillas, chimpanzees and monkeys) with an extremely high case fatality rate in humans ranging from 25 – 90% depending on the subtype and the availability of medical care. Haemorrhagic symptoms occur in about 30-50% of described human cases.

One Marburg virus subtype and 5 Ebola virus subtypes have been identified to date. See Table 1. The 5<sup>th</sup> Ebola subtype was recently recognized in an outbreak in Western Uganda in 2007/2008.

**Table 1. Subtypes of Filovirus Haemorrhagic Fever (FHF)**

<b>Subtype</b>	<b>Remarks</b>
Marburg virus	Identified in 1967 in Germany. Case fatality rate 25-90%
Ebola Zaire (EBO-Z)	Identified in 1976 in former Zaire. Subtype with highest case fatality rate, 70-90% for human.
Ebola Sudan (EBO-S)	Identified in 1976 in South Sudan. Case fatality rate 50-70% for human.
Ebola Reston (EBO-R)	Identified in 1989 in Reston (USA) in a primate centre with imported monkeys from the Philippines. Few humans got infected, but didn't develop symptoms.
Ebola Ivory Coast (EBO-IC)	Identified in 1994 in Ivory Coast, caused 2 symptomatic non-lethal human infections, but high mortality within chimpanzees in a nature park.
Ebola Uganda (EBO-U)*	Identified in 2007 in Uganda. Case fatality rate $\pm$ 25% for human. *

\* Official data and official name of subtype not yet published at moment of writing.

Four Ebola subtypes (Zaire, Sudan, Ivory Coast and Uganda) and the Marburg virus cause illness in humans and the subtypes Zaire and Ivory Coast and the Marburg virus are also known to cause illness in non-human primates. One Ebola subtype (Reston) causes illness in non-human primates, but has induced so far known only asymptomatic disease in humans.

**Table 2. Overview of Marburg outbreaks, source World Health Organization (WHO), [www.who.int](http://www.who.int)**

Year	Country	Cases	Deaths	Case fatality
1967	Germany and Yugoslavia	32	7	21%
1975	South Africa	3	1	33%
1980	Kenya	2	1	50%
1987	Kenya	1	1	100%
1998-2000	Democratic Republic of the Congo (DRC)	154	128	83%
2004-2005 (Oct-Oct)	Angola	374	329	88%
2007 (Jul-Se)	Uganda	3	1	33%
	<b>Total</b>	<b>570</b>	<b>468</b>	

**Table 3. Overview of Ebola outbreaks, source WHO**

Year	Country	Ebola virus subtype	Cases	Deaths	Case fatality
1976	Sudan	Ebo-S	284	151	53%
1976	Zaire (DRC)	Ebo-Z	318	280	88%
1977	Zaire (DRC)	Ebo-Z	1	1	100%
1979	Sudan	Ebo-S	34	22	65%
1994	Gabon	Ebo-Z	52	31	60%
1994	Ivory Coast	Ebo-IC	1	0	0%
1995	Liberia	Ebo-IC	1	0	0%
1995	DRC	Ebo-Z	315	250	81%
1996 (Jan-Apr)	Gabon	Ebo-Z	37	21	57%
1996/1997 (Jul-Jan)	Gabon	Ebo-Z	60	45	74%
1996	South Africa	Ebo-Z	1	1	100%
2000/2001	Uganda	Ebo-S	425	224	53%
2001/2002 (Oct-Mar)	Gabon	Ebo-Z	65	53	82%
2001/2002 (Oct-Mar)	Congo-Brazzaville	Ebo-Z	59	44	75%
2002/2003 (Dec-Apr)	Congo-Brazzaville	Ebo-Z	143	128	89%
2003 (Nov-Dec)	Congo-Brazzaville	Ebo-Z	35	29	83%
2004 (May-Aug)	Sudan	Ebo-S	17	7	41%
2005 (May-June)	Congo-Brazzaville	Ebo-Z	12	9	75%
2007 (Jul-Oct)	DRC	Ebo-Z	223	179	80%
2007/2008 (Nov-Jan)	Uganda	Ebo-U	149	37	± 25%
	<b>Total</b>		<b>2232</b>	<b>1503</b>	

## Reservoir

The natural reservoir of the Ebola and Marburg viruses remains unknown.

The transmission dynamics and often rapidly fatal nature of the disease mean that humans and non-human primates are not likely to be the natural reservoir. Traces of filovirus infection have been found in some species of bat in tropical Africa, although the significance of this is not yet certain.<sup>1 2</sup> Once the first human gets infected (the so-called index case), human-to-human transmission can occur.

### Route of transmission and amplification

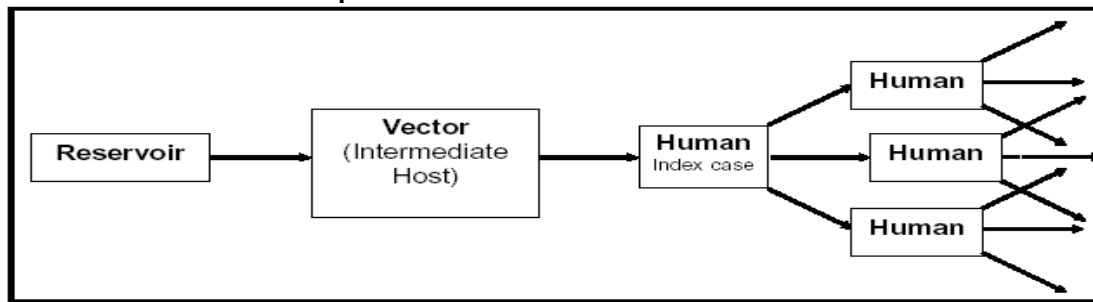

The area where infections occur is usually limited, probably by the geographical limits of its natural host. Outbreaks can occur outside this area when an infected animal is exported outside the native habitat and can then be responsible for primary infections in humans. Infected human traveling outside the area where he/she became infected can spread the disease to other human (secondary infections).

## 2. Transmission, period of communicability, carriers and immunity

### Modes of transmission

#### • **Contact with the natural reservoir or infected animals:**

Humans and non-human primates can be infected after being in contact with (e.g. having touched or eaten) the unknown natural host or an infected animal. This is an uncommon way of transmission, but has to occur at least once to initiate an outbreak.

#### • **Direct contact with infected body fluids of an infected patient:**

Contact with blood, urine, excreta, vomit, saliva, sweat, mother's milk, organs, body parts, secretions and sperm (the virus can be found in semen up to 3 months after clinical recovery of Marburg infection) can lead to infection and this is the major mode of transmission in most outbreaks.

Routes of infection are:

- oral
- via the conjunctivae
- after mucous-membrane exposure: nose and mouth
- via sexual intercourse
- via a break in the skin
- via a penetrating object infected with body fluids of a patient, e.g. needles or razor blades.

Infections occur when health staff or relatives are taking care of a patient without proper protection (PPE = Personal Protective Equipment).

---

Epidemiological evidence shows that aerosol transmission does not play a role in the transmission.

---

- **Contact with infected corpses (human or animal):**

Bodies of deceased patients or animals that died of FHF infection are highly contagious because of the high levels of virus in the corpses. Often traditional burial rituals consist of washing and touching the body to prepare the body to be returned to the ancestors. People touching and washing the corpse are at high risk to contract the disease and this is a well-documented, major mode of transmission.

- **Nosocomial transmission:**

Needles, syringes and material contaminated with infected fluids, can cause infections in health staff and patients. When medical items are re-used without adequate sterilization on patients attending a health facility, numerous people and health staff can get infected. If no hand washing takes place in between consulting patients, infections can spread between health staff, and from health staff to other patients. The importance of this mode of transmission has shown to vary from outbreak to outbreak.

---

Community spread mostly occurs through a social network: when friends and relatives are taking care of a patient or when participating in funeral activities.

---

### **Period of communicability**

The window period between exposure and development of symptoms is thought to be a minimum of 48hrs. During the incubation period the patient is infected with the virus, but is asymptomatic and is not contagious. (Incubation time for Ebola and Marburg is 2-21 days).

During the first days of symptoms the levels of the virus increases and therefore its communicability increases rapidly. If the patient doesn't manage to establish a proper immune response, then the level of the virus continues to increase until death occurs. The corpse of a patient who died of FHF infection is therefore highly contagious.

If the immune response is sufficient, then the level of virus decreases gradually until recovery.

### **Carriers**

So far no evidence has been found that people can be a carrier of a FHF virus.

Although there is some evidence that mild or asymptomatic cases do occur, these individuals are likely to have low viral loads and are unlikely to be a significant factor in transmission. In epidemics, infections can normally be linked to other symptomatic cases within the timeframe of the incubation period.

### **Immunity**

Patients surviving a FHF infection develop an immune response and produce immune globulin G (IgG) in the blood. Cellular immunity is likely to play a more important role than antibody mediated immunity. The period of protection and possible cross protection for other subtypes is not been documented.

### 3. Sensitivity of the virus

It is believed that the Filovirus is not capable of surviving a long time outside the body of an infected organism. The virus is thought to be able to survive up to some days in a liquid (blood, vomit, corpses, etc). However having a lipid (fatty) envelop makes the viruses fragile. Chlorine disinfection, heat, direct sunlight (UV light), soaps and detergents all destroy the lipid envelop of the virus, thereby killing the virus.

### 4. Clinical features of a FHF infection

#### Incubation period

There is no evidence that the virus can be transmitted during the incubation period. During outbreaks the incubation period used by all organizations is 2-21 days for Ebola and Marburg. The most common incubation period is between 4-10 days, as mentioned by WHO and CDC, but with this contagious and lethal disease it is important to catch outliers and therefore a large margin of safety is used to calculate the incubation period.

Virus	Incubation period
Ebola and Marburg virus	2 - 21 days

#### Pathophysiology

The virus can replicate in various human cells. Target cells for the virus are mononuclear cells, hepatocytes and vascular endothelia cells. Mononuclear and dendritic cells (that are involved in the immune response) are the first to be infected, leading to an immune suppression. As the disease progresses parenchyma cells, like hepatocytes and adrenal cortical cells, are infected, thereby affecting the function of liver and kidneys.

Massive release of inflammatory mediators causes an increase in vascular permeability leading to shock; and disseminated intravascular coagulation, leading to coagulopathy and bleeding.

The virus can finally affect almost all organs leading to multiple organ failure (MOF) and cause widespread cell death.

The immunological response in the beginning of the infection will decide how fast the virus will multiply and if the evolution will be catastrophic or towards cure. The faster the antibodies immunoglobulin M (IgM) and Ig G appear, the more chance the patient has to survive.

Death or recovery normally takes place between 10 –14 days after onset of disease.

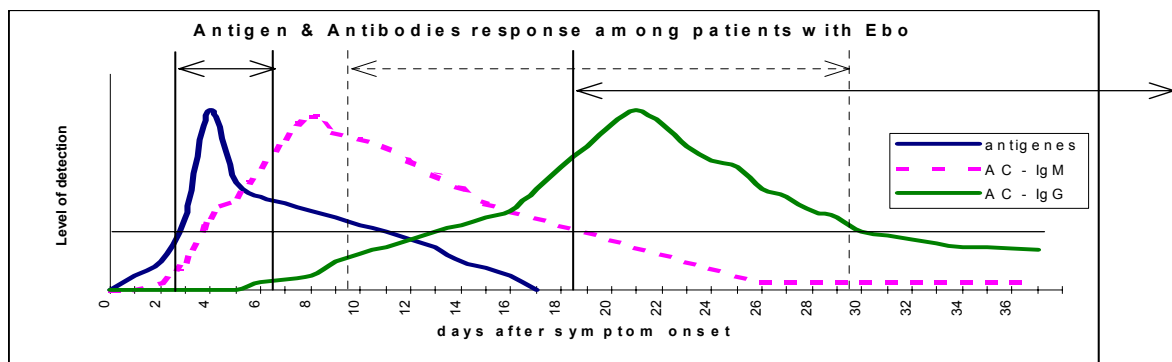

### **Clinical symptoms**

Ebola and Marburg viruses cause similar symptoms. Symptoms start generally and are similar to common tropical diseases like malaria, shigellosis or typhoid. A clinical diagnosis is therefore difficult. Symptoms develop progressively and filovirus infections can kill rapidly.

<u>General symptoms:</u>	<u>Then often followed by:</u>
<ul style="list-style-type: none"><li>• Intense tiredness and weakness</li><li>• Sudden onset of fever: &gt; 37.5 axillary (fever may be absent in late stages)</li><li>• Headache</li><li>• Muscle pains</li><li>• Arthralgia</li><li>• Hiccups</li><li>• Conjunctivitis (1/3 of all patients after 5 days)</li><li>• Nausea and anorexia</li><li>• Painful throat and dysphagia</li><li>• Abdominal pain</li></ul>	<ul style="list-style-type: none"><li>• Chest pain</li><li>• Diarrhea (watery or bloody)</li><li>• Vomiting (sometimes bloody)</li><li>• Orchitis</li><li>• Rash</li><li>• Confusion and irritability</li><li>• Internal and external bleeding (in 30-50% of cases, often from mucosa and gingivae)</li><li>• Impaired liver and kidney function (MOF)</li><li>• Abortion or miscarriage amongst pregnant women</li><li>• Shock</li><li>• Death</li></ul>

### **Possible predictors of death**

Based on experience in former FHF outbreaks and on anecdotal evidence, there are some indicators and symptoms that can predict a fatal outcome from the disease:

- Early in the epidemic: the symptoms and case fatality rate tend to be worse in the first cases of the outbreak and less severe at the end of the outbreak, possibly due a higher virulence at the beginning of an outbreak.
- High contaminating dose of infectious fluids.
- Late or no appearance of immune globulins.
- Pregnancy: so far no pregnant woman has been reported to survive Ebola or Marburg Haemorrhagic Fever
- < 5 yrs of age
- Fast progression of the symptoms
- Bleeding signs
- Tachypnoea
- Early onset of edema
- MOF (Multiple Organ Failure)

### **Convalescent patients**

Convalescent patients will be extremely weak for some weeks and nutritional support may be needed and should be provided by MSF. In a few surviving patient uveitis occurred with ocular pains, photophobia, hyper lacrimation and loss of vision.

The virus has been detected in the semen until 3 months after the unset of the disease in Marburg (not documented in Ebola). Recovering patients need to be instructed to use and provided with condoms during this 3 months period.



## 5. Treatment and vaccine

To date there is no curative treatment available for Ebola and Marburg Haemorrhagic Fever. Intensive supportive care is the only treatment that can be provided to the patients and may have a positive impact on the outcome.

Promising vaccines are in development, but are not yet ready for field use.

## 6. Impact of a FHF outbreak

Outbreaks are rare and of limited public health importance in terms of mortality.

However, outbreaks still have a huge social and sometimes economic impact due to the fear, stigmatization, quick spreading of the disease, the high infection rate amongst the health staff and the high case fatality in general. Moreover, several members of the same family often get infected and die when taking care of each other.

The fear, mystery, paranoia and unfamiliarity related to the disease often provokes people to flee from the immediate area and makes it difficult to find (medical) national staff willing to work in the intervention or to continue their regular work in the health facilities.

The high case fatality rate, high infection rate of patients attending health facilities, and lack of curative treatment, all lead to a decreased confidence in the medical system and reduced attendance to the health system by the community in an outbreak area. These effects can last a long time after the actual outbreak is declared over. Curable diseases like malaria might not be treated and may cause more deaths than the filovirus itself.

Medical staff wearing full protective clothes (PPE) while caring for FHF patients might add to community fears and distrust. Media attention also contributes greatly to fear and paranoia about haemorrhagic fever outbreak worldwide.

### **Key points**

- Ebola and Marburg Haemorrhagic Fever can spread quickly and are lethal with a 25-90% case fatality rate.
- Humans and non-human primates can get infected with the virus.
- The disease starts with general symptoms, followed by multiple organ failure, haemorrhagic signs, shock and death.
- Outbreaks start in tropical rainforest regions, but due to the increased mobility of the people in these areas there is an increased risk of the disease spreading fast if it reaches an urban setting.
- The natural reservoir remains unknown.
- Transmission modes are contact with the natural reservoir, via body fluids and corpses of infected human and non-human primates or nosocomial infections acquired in health structures.
- Caretakers and health staff are at risk to get infected if no proper precautions (PPE) are taken.
- There is currently no effective treatment or vaccine available, but intensive supportive therapy may have a positive impact on the clinical outcomes.

## Chapter 2. Outbreak investigation, sample taking and case definition

In most outbreaks partners like the Ministry of Health (MoH), WHO or Centre for Disease Control (CDC) will be the first to send a team to do an outbreak investigation, to take and send samples for confirmation, and to declare an outbreak.

After the declaration of the outbreak, normally Medecins Sans Frontieres (MSF) is asked to participate in the intervention strategies. Coordination within the Task Force will need to take place to divide the activities of the intervention between the partners according to their experience in other outbreaks. See **Chapter 3. Intervention strategies.**

The fast set up and organization of an isolation facility is the priority action. See **Chapter 4. Set up, organization and activities in isolation facilities.**

In some cases MSF plays a role in an outbreak investigation. There are 2 scenarios:

- A. The MSF assessment team will be the first to do the assessment and to take samples of suspected cases for confirmation.**
- B. A FHF outbreak is ongoing and interventions have started. There is a suspect case outside the epidemic area and MSF is asked to investigate the case.**

In all scenarios good communication should take place between field, capital and Headquarters level and with the Task Force partners.

### **A. MSF will be the first to do the assessment and to take samples of suspected cases for confirmation.**

Taking samples is a high-risk procedure and the use of Personal Protective Equipment (PPE), disinfection and specific waste disposal measures are essential while taking samples.

#### **1. Triggering the alert**

The outbreak of an Ebola or Marburg epidemic is suspected when:

- There are rumors of people dying with haemorrhagic symptoms.
- There is an abnormal and unexpected increase in mortality in a certain area, particularly in members of the same family or one village.
- Numerous health staff have fallen sick or died.
- There is an abnormal and unexpected increase in mortality in non-human primates.
- Outbreaks of filovirus haemorrhagic fevers have occurred in previous years in the same or neighboring regions.

---

Always be aware that different outbreaks can occur at the same time, e.g. shigellosis or typhoid concomitant with FHF.

---

## 2. Exploratory mission

As soon as there is a suspicion of a FHF outbreak, an exploratory mission needs to be sent as quickly as possible to investigate. Samples should be taken for confirmation and a place should be created to isolate suspected patients.

*Module 7\* of the Viral Haemorrhagic Fever (VHF) Kit - See Annex 1. Module 7 - Sampling and Assessment - contains all materials and equipment necessary for safely carrying out an assessment: examining patients, collecting samples, and packaging and transporting the samples according to IATA regulations.*

\* Module 7, MSF code KMEDZTF0072 – Sampling and Assessment Module should be part of the Emergency Preparedness Plan in all countries with previous FHF outbreaks and should be available at capital level.

## 3. Confirmation of diagnosis by laboratory testing

Laboratory confirmation is recommended in order to:

- Confirm an Ebola or Marburg outbreak
- Identify the subtype

### Identify a laboratory

Ebola and Marburg samples are classified in Infectious substances Category A, i.e. an infectious substance in a form that, when exposure to it occurs, is capable of causing permanent disability, life-threatening or fatal disease in otherwise healthy humans or animals.

Testing of samples to detect the filovirus can only be done in laboratories that are equipped with Biosafety Level p4 facilities. In most countries where filovirus outbreaks occur, such a laboratory is not available and the samples need to be sent to a Reference Laboratory. See **Annex 2. Authorized Filovirus testing Centers and WHO contact information.**

Before an exploration team is sent to assess a rumor of an outbreak, Headquarters needs to have identified and contacted a Reference Laboratory to inform them that a sample will be sent, to inquire which type of samples should be taken and to verify the sampling procedures required.

### Patient selection for samples

Clinical diagnosis of Ebola and Marburg is very difficult, because symptoms are non-specific and similar to common tropical diseases. In an outbreak investigation, samples should be taken from suspected patients or from corpses from patients who just died (max. 1-2 days). See **Annex 3.B Suggested case definitions.**

### Sample taking

There are different types of samples that can be taken:

- Whole blood (from living suspect cases or from patients shortly after death via vena-puncture or until 2 days after death via cardiac puncture)
- Oral swabs (can be taken from both living and dead suspect cases)
- Skin snips and liver biopsy (from corpses)

Blood samples are normally recommended for testing patients, but there are risks to the staff taking and handling the samples.

### **Quantity of samples to be taken**

In order to determine the infectious agent of the outbreak, blood may need to be tested for a number of agents, such as Marburg, Ebola and Rift Valley Fever. It is therefore necessary to discuss this with the laboratory to be used and take a sufficient amount of blood (5-10 ml) to allow them to do all the tests required. This may require sending more than one tube of each type for each patient. It is normally recommended to send:

- EDTA tubes (with anti-coagulation, purple cover)
- Dry tubes (without anti-coagulation, red cover)

### **Conservation per transport medium**

For information on conservation per transport medium see **Annex 4. Sample information and conservation per transport medium**. All samples should be properly labeled with name, address, sex, age and date of sample taking, and accompanied with a clinical description of the suspected case.

*Module 5 – Sampling; Prelevement - of the VHF Kit contains all sampling and transportation material needed and is according to IATA regulations. Module 5 is included in Module 7.*

### **Available laboratory tests**

Different laboratory tests can be performed on the samples for confirmation of a FHF outbreak. See **Annex 5. Laboratory tests**.

### **Triple layer packaging**

Samples should always be safely packaged during any transport (i.e. during the trip in the country and when sending outside the country, but also e.g. when a field laboratory might be available during a confirmed outbreak and the sample need to be transported only for a short distance).

A triple-packaging system should be used to prevent any leakage and contamination.

Each sample should be protected by 3 layers and each layer should be disinfected with 0.5% chlorine solution. Example of a blood sample:

#### **Layer 1:**

- Collect the blood in a collection blood tube.
- Disinfect the complete outside of the collection tube with 0.5% chlorine solution after taking the sample.

#### **Layer 2:**

- Disinfect the inside and outside of a plastic waterproof box and put the sample (e.g. whole blood in tube) inside.
- Put absorbent paper or cotton wool around the sample tube in the waterproof tube and close it.
- Disinfect the outside of the waterproof tube.
- (Two blood sample tubes from the same patient can be put in a collection bag and then put in the plastic waterproof tube, after the bag is being disinfected in- and outside.)

#### **Layer 3:**

- All items should be put in a special cartoon box with the international label for transport of Infectious Substances (UN2814).
- When leaving the High-risk area the cartoon box should be sprayed with 0.5% chlorine solution.

---

For extra protection, the sample (e.g. collected in a blood tube) can be put first in a plastic waterproof tube (bigger than blood tube) before putting in the plastic waterproof box and then in the carton box. In this case the blood tube is not counted as first layer.

---

### **Transport of the sample**

Transport should follow strictly the rules of the IATA (International Air Transport Association). The field team can send the samples straight to the Reference Laboratory while following the sample transportation protocol for Infectious substances described in **Annex 6. Sample collection: Transportation and IATA regulations**. The moment the sample will be sent, the field team needs to inform the Headquarters and then the Headquarters will need to inform the Reference Laboratory about the arrival of the samples.

### **Laboratory confirmation**

Definition of interpretation (See **Annex 5. Laboratory tests**):

1. Confirmed case: Laboratory test found positive: Antigen +, PCR +, IgM+ or IgG+ (IgG can be positive from an earlier infection!)
2. Indeterminate case: Antigen or PCR negative between 0-3 days after onset of symptoms and clinically a suspect case.
3. Non-case: Antigen negative or PCR negative on day 4 or later after onset of symptoms

## **4. Case definitions**

To identify suspect and probable cases and to isolate them as fast as possible case definitions are essential. Case definitions need to be defined as early as possible during every new outbreak. They should be easy to understand and agreed upon by all partners involved in the FHF outbreak.

Different levels of case definitions can be used according to the level of sensitivity or specificity needed. See **Annex 3.A Case definitions and their use**. E.g. a high sensitivity is needed at community level to include all possible cases at the alert stage, while a high sensitivity and a high specificity is required for suspect and probable cases.

The different case definitions can be revised, but changes should be clearly noted when interpreting data. See **Annex 3.B Suggested case definitions**. Case definitions inside the area of an already confirmed epidemic and outside the epidemic zone can be different.

## **5. Describing the situation**

Collection and analyzing of data is needed to describe the situation during the whole period of an outbreak. Activities and intervention strategies can be planned and organized according to the situation. During the assessment a quick analysis is needed, while during the continuation of the intervention data collection and analysis can provide more detailed information. Data collection should be started during the assessment.

Transmission chains within and between a families or groups of friends or colleagues need to be recognized as quickly as possible to be able to stop the transmission and to understand the outbreak. Information needs to be collected on any previous FHF outbreaks in the area.

Collecting, organizing and analyzing data are essential to describe the situation.

## **A. Collection of data**

### **Number of cases and deaths**

- Health centers and hospitals can provide information about number of cases (using case definitions) and number of deceased people.
- If not already in use, a register should be put in place for essential data collection: name, age, sex, address, symptoms, date of onset and admission, treatment and outcome.
- The first identifiable case, (index case) should be traced to mark the start of the outbreak.
- Data collection should be gathered starting from the beginning of the outbreak until the declaration of the end of the outbreak.

### **Demographic data**

Demographic data are available from local authorities. Population numbers need to be collected at the most finite level: district, village or city zone.

## **B. Organizing data by person, time and place**

### **By person**

The number of cases and deaths need to be collected on a daily base. No specific age groups are required for data collection at this stage of the outbreak, as age groupings will be done at the analysis stage. The age of the patient should be recorded.

### **By time**

The weekly number of cases and deaths need to be put in an epidemic curve to show the evolution and amplitude of the epidemic over time.

### **By place**

The geographic distribution of cases per village/district can be used to identify areas at greater risk and the geographical scope of the outbreak can be mapped. The epicenter needs to be marked.

## **C. Analyzing data: Weekly incidence rate, Attack rate and Case Fatality Rate**

Weekly incidence rate, attack rate and case fatality rate are important indicators to follow an epidemic.

### **Weekly Incidence Rate (WIR):**

Incidence shows the rate at which new cases occur within a given period of time (usually one week).

WIR can be expressed per hundred persons (percentage) or per 1.000 or 10.000 etc.

$$\text{WIR} = \frac{\text{Number of new FHF cases during the week}}{\text{Population at risk for FHF during the same week}} * 100 \text{ (or 1.000 or 10.000)}$$

### **Attack Rate (AR):**

AR is the cumulative incidence of FHF over a defined period of time or the whole duration of the epidemic. AR is usually expressed as percentage.

$$\text{AR} = \frac{\text{Total number of FHF cases during a certain period}}{\text{Population at risk for FHF during the same period}} * 100$$

### **Case Fatality Rate (CFR):**

CFR is the proportion of fatal FHF cases within a specified period of time, expressed in percentage.

$$\text{CFR} = \frac{\text{Number of deaths caused by FHF during the week}}{\text{Number of probable and confirmed cases of FHF notified during the same week}} * 100$$

## 6. Assessing the response capacity of the health system

The exploration team needs to do a quick assessment of the capacity of the national health system to evaluate response capacity. See **Annex 7. Site assessment form for Health centers** for an example.

Information needs to be gathered about:

- Available human resources: names and positions of personnel
- Buildings: Level of healthcare i.e. hospital, health centre, health post; amount, place, etc.
- Supplies: Availability of protection material, Ringers lactate, medicine etc.
- Accessibility: Distances, accessibility by road (car, motorbike), etc.
- Security

## 7. Identifying priority areas for intervention

The assessment team can advance to identify priority areas for intervention if needed according to the situation. Priority areas can change with time: re-location of activities should always be possible.

Priority areas for intervention are identified by:

- Epidemiological patterns: Numbers of cases and deaths, and ‘epicenter’ of the epidemic.
- Logistical possibilities: Accessibility by air and/or road, possibility of freight transportation.
- Security situation.
- Available resources: human resources, health facilities, etc.
- Limited response capacity of health authorities.
- Determine the best isolation options: in hospital, health centers or other structures.

---

**While the assessment is ongoing, all suspected patients should be isolated and treated according to the possibilities.**

---

## 8. Reporting and formulating recommendations for action

---

**A formal report should conclude the initial assessment.**

---

The report should answer to the following questions:

- Is it a FHF outbreak? Is it confirmed? If yes, how and where? Which subtype?
- What is the case definition used or proposed?
- Has there been an FHF outbreak before in the area?
- How many (suspected and confirmed) cases and how many deaths?
- What is the geographic distribution of cases? Where is the epicenter?
- What are the weekly incidence rate, attack rate and case fatality rate?
- Show the epidemic curve.
- Brief description of coping capacity of health services.
- Where are the areas at high risk?
- How is the response of the health staff and community so far? (Number of infected health staff or fleeing health staff, reaction of community, etc.)
- What is the response from the authorities and other actors present? State of current isolation facilities if existing?
- **Recommendation for action:** See following chapters for intervention strategies.

## **B. A FHF outbreak is ongoing and interventions have started. There is a suspect outside the epidemic area and MSF is asked to investigate the case.**

During an outbreak, areas bordering the epidemic area will be alert for any haemorrhagic fever suspicion and often rumors arise of suspected cases. A team needs to take sampling and assessment material with them, assess the rumors, take samples and isolate patients if considered necessary. Once an outbreak is declared, it is likely that laboratory facilities for filovirus infection confirmation will be in the country and a fast laboratory result can be expected. See **Annex 8. Standards for providing samples in filovirus outbreaks with the laboratory in the country**. Samples should be transported with triple layer packaging as described before.

If a positive laboratory test is found, action should be taken according the situation. (E.g. patients can be transported to the existing isolation facilities or a new Marburg/Ebola ward can be set up.)

### **Key points**

- MSF can be involved in the initial assessment when an outbreak investigation is needed or when there is a rumor outside the epidemic area.
- Be alert for a FHF outbreak when people are sick or dying with hemorrhagic symptoms, when several health staff are sick or have died, or when there is an increase in mortality for humans or non-human primates
- The assessment team needs to take samples, give a preliminary description of the extent of the outbreak and isolate suspected cases.
  - Protection and disinfection should be used when attending suspected patients, taking samples or when in contact with corpses, as if it was a FHF outbreak until the diagnosis is known.
  - Samples from suspected patients (or corpses) need to be sent to a (Reference) laboratory with Biosafety Level p4 using triple layer packaging, following IATA regulations or, if available, to the laboratory with filovirus testing in the country once an outbreak has been declared,
  - Standard data collection system needs to be started in all health facilities as soon as possible.
  - The epidemic needs to be described in terms of person, time and place.
  - Incidence rate and case fatality rate needs to be analyzed by time and place.
  - Health system capacity to respond needs to be investigated.
  - Suspected cases need to be isolated.
- A case definition needs to be agreed upon by all key actors.
- Identify priority areas for intervention.
- Report and formulate recommendations for MSF Headquarters



## Chapter 3. Intervention strategies

### 1. Objectives

---

The main objectives of the intervention strategies are:

1. Reduce the spread of the FHF epidemic.
  2. Reduce the mortality and suffering by providing optimum patient care.
- 

**Objective 1:** Can be reached by:

- Isolating all suspected, probable and confirmed cases.
- Infection control measures and barrier nursing
- Detection of all patients by setting up a surveillance system: contact tracing and following contacts, rumor checking and case detection via triage points in health settings.
- Safe transport to Marburg/Ebola ward.
- Disinfection of risk areas.
- Safe burial procedures of FHF patients that died in the Marburg/Ebola ward or at home.
- Tracing and intervening in transmission chains between contacts.
- Providing information to the community about the disease, how to recognize alert cases, and prevention of transmission.
- Restriction of high-risk procedures in all health facilities in the area of the FHF outbreak (MoH, MSF and others): limitation of invasive procedures, and surgical and laboratory activities to only life saving procedures, and stop of vaccination activities.

**Objective 2:** Can be reached by:

- Setting up of well-organized Marburg/Ebola facilities with well-trained staff.
- Providing maximum supportive treatment and nursing care.
- Providing psychosocial support to patients, family members and the community.

---

Both objectives must be implemented in parallel.

---

Systemic data collection and analysis of data can contribute to the understanding of filoviruses and a possible improved response in future outbreaks. Data from the MSF-supported Marburg/Ebola units should be collected using standard forms and databases:

- Epidemiological data
- Clinical data
- Treatment data: more information and a better understanding are needed about the effects of the different supportive and/or experimental therapies.

### 2. Coordination, collaboration and Task Force/Crisis Committee

Many activities must be put in place at the same time and as fast as possible once an outbreak is detected. A crisis committee at national/regional level must be put in place to coordinate and share all information regarding resources, needs and strategic orientations.

Daily meetings should be arranged throughout the outbreak to update the partners and optimize the collaboration.

This committee should include representatives from all partners involved in the outbreak:

- The Ministry of Health
- (Inter)national agencies: e.g. NGO's such as MSF, W.H.O., UNICEF, ICRC, etc.
- Laboratory facilities: international e.g. CDC or Health Canada and national.

**Main activities of the Task Force:**

- Determine priority areas for interventions.
- Divide the intervention strategies according to experience and human resources of the partners: define who is doing what.
- Agree on case definitions and community messages.
- Coordinate a sufficient supply of means needed in a FHF outbreak.
- Information sharing and transparent collaboration.

---

The Viral Haemorrhagic Fever Kit, 10 beds/10 days, MSF code KMEDZTF0065, with all drugs and material needed for 10 days for 10 admitted patients in a Marburg/Ebola unit, can be ordered if necessary.

---

### **3. Top Ten Priorities when starting an intervention**

This guide and the Ebola & Marburg Outbreak Control Guidance Manual with the protocols and procedures described will help in implementing the outbreak control activities. However, do not follow everything blindly; every situation will be different and will require adaptations. It is important that the rationale for doing certain things, and performing tasks and activities in a specific manner is understood. Then, when unforeseen situations arise, the situation can be managed and procedures can be adapted safely, or another solution can be found.

The Top Ten Priorities should be kept in mind when starting an intervention. Most of the activities can and should be done concurrently.

**Top Ten Priorities to Start the Intervention**

1. Protect yourself
2. Collect and analyze information
3. Coordinate
4. Care for existing FHF patients
5. Decontaminate
6. Communicate
7. Identify and train staff
8. Plan and start installation of Marburg/Ebola ward
9. Organize patient identification and transportation
10. Ensure safe practices in other health services

**Key points**

- Objectives of intervention strategies:
  - Reducing the spread of the epidemic
  - Reducing mortality and suffering
- Objectives must be implemented parallel.
- Coordination and collaboration with all partners involved

## Chapter 4. Set up, organization and activities in isolation facilities

---

FHF patients are highly contagious and need to be isolated and cared for using barrier nursing to avoid spreading the infection.

---

The first focus of intervention strategies is to set up a Marburg/Ebola ward where all suspected, probable and confirmed cases can be admitted. The Marburg/Ebola ward should be operational as soon as possible. Normally a good running Marburg/Ebola unit takes around a week to 10 days to be installed, depending on the circumstances.

Patient care should be started before the Marburg/Ebola ward is ready, at the moment when appropriate training, personal protective clothing (PPE) and basic provision of disinfection are provided and waste disposal arrangements are made.

On arrival in an outbreak area, often patients will already be isolated in a temporary isolation area by MoH staff or by the outbreak investigation team.

Sometimes patients or their relatives don't accept being admitted to the Marburg/Ebola unit and in those cases Home Based Risk Reduction can be implemented to bridge the time and stay in communication with the family until hospitalization is accepted. However it remains a dangerous alternative and it is not possible to provide pro-active supportive treatment.

### 1. Community acceptance of the Marburg/Ebola ward

Isolation ward or unit might have a negative association for the community. Therefore it is better to avoid using the term 'isolation' and instead using the term Marburg/Ebola unit or ward.

It is essential that the community accept the Marburg/Ebola ward in order for it to be effective as epidemic control system and to be able to give patient care.

Patients and relatives may be extremely reluctant to accept admission in the Marburg/Ebola ward.

There is a great fear of the disease and people can be reluctant to acknowledge that they may be infected. Also the possible stigmatization of the patients and their families can be a reason to refuse admission in the Marburg/Ebola ward.

Furthermore people may be aware of the low survival chances and the lack of curative treatment and therefore prefer to be cared for and to die at home surrounded by their families and not by strangers in a frightening environment.

#### **Activities to increase community acceptance and collaboration**

Health promotion and activities that reduce the mystery around the Marburg/Ebola unit can help to increase community acceptance.

##### **A. Health promotion activities and information campaigns about FHF.**

Health promotion and information providing activities are essential to increase community acceptance and should ideally start from the first day of the intervention. See **Chapter 9. Health promotion and psychosocial support.**

Explanation needs to be given about:

- The features of the disease.
- The rationale of the Marburg/Ebola ward and the strict infection control rules.
- Other outbreak control activities.
- The type of medical care that can be offered to patients.

### **B. Demystification of the Marburg/Ebola ward.**

Communities often fear Marburg/Ebola wards. To reduce the fear and the mystification of the ward it is important to:

- Set up the Marburg/Ebola ward in a transparent way to make the activities visible: e.g. use low or mesh fences so people can see what is happening and create spaces where patients can communicate to their families.
- Provide good supportive medical and nursing care in a proper environment.
- Allow caretakers to visit the patient during visiting hours when adequate infection control is in place and after explaining them the procedures, providing them with protective cloths and accompanying them.
- Invite community leaders and other key people for a visit to the Marburg/Ebola ward so that afterwards they can communicate to their communities about the activities, thereby reducing negative rumors.
- Survivors can work in Health promotion activities to talk about their personal experiences of having being admitted in the Marburg/Ebola ward.

## **2. Set up and organization of the Marburg/Ebola unit**

The set up of the Marburg/Ebola ward should allow activities to be performed in an easy manner with a clear, rational movement and circulation of people and materials. Minimizing complexity, confusion and physical exercise contributes to create a safe working environment.

Communication with local (health) authorities will need to take place when choosing a location and buildings/structures for the Marburg/Ebola unit.

### **Location**

A single Marburg/Ebola unit is the easiest to manage in terms of training, human resources and logistics. However, there may be circumstances that require 2 or more settings e.g. when dealing with several focal points of the outbreak.

The location of the Marburg/Ebola ward should be:

- As close as possible to the epicenter of the outbreak to minimize movements.
- Easily accessible by cars (ambulance, material, water trucking, etc.)
- At a strategic point to have sufficient water supply available.
- Spacious to allow adequate space for all activities in the Marburg/Ebola unit.

### **Buildings/structures**

If there is an isolation area already in use when MSF arrives this can be improved for further use, or a new isolation area can be built. Creating a new isolation area has shown to be the fastest option in former outbreaks. Existing health structures or other buildings can be used. If no appropriate buildings are available tent structures can be used, however good infection control will be difficult, and tents can become extremely hot unless sheltered from the sun.

Suspected and confirmed cases need to be accommodated in different areas or buildings to avoid cross infection. In some settings a probable cases area can be created or divisions can be made in the suspected or confirmed area where the probable cases can be admitted.

- Beds need to be adequately separated to ensure privacy and prevent transmission of the virus.
- Wards/patient rooms should have a good ventilation to reduce heat and humidity and to evacuate chlorine gas.
- Mosquito net use is not recommendable due the disinfection procedures, but mosquito screening and insect traps can be installed on windows instead.

### **Risk zones**

There are 3 different risk areas according to their level of risk:

**A. The High-risk zone** is an area inside the isolation facilities:

- Main activities: Patient care, deceased patient's body preparation for burial and disposal of contaminated waste. All waste from Low-risk zone is transferred to the High-risk zone for disposal.
- Contamination: The zone is highly contaminated and everything in this area is considered as being contaminated including buildings, personal belongings, paperwork, patients and staff (prior to disinfection and removal of PPE).
- Clothing: Scrub suit, boots and PPE for the staff and adapted PPE for visitors. (Except for patients, who are admitted in normal clothes).
- People: Only patients, designated staff and authorized visitors are allowed inside.

**High-risk zones** outside the isolation facilities may include:

- Patient's and deceased patient's houses.
- Morgues.
- Medical laboratories and operating theatres.
- Traditional health services.

**B. The Low-risk zone** is an area inside the isolation facilities:

- Main activities: Supporting activities including dressing, laundry and storage.
- Contamination: In principle no infectious material should remain, however there is real potential for contamination to occur due to uncontrolled movement of contaminated people or material.
- Clothing: All people entering the Low-risk zone change into scrub suits and boots.
- People: Medical staff, cleaning staff, water/sanitation and logistic staff, etc.

**C. Outside the Marburg/Ebola unit.**

No infectious material should be present outside the isolation facilities, but in an epidemic situation infectious material or persons can be anywhere. There is no 'no-risk zone' in a FHF outbreak.

### **Activities and facilities in the different risk zones**

Different activities and facilities are required inside the different risk zones in the Marburg/Ebola unit:

#### **A. High-risk zone**

- Ward(s) or rooms for suspect patients.
- Ward(s) or rooms for confirmed patients
- Ward/Space for probable patients.

The following facilities should be available in **both** suspected and confirmed areas (i.e. 1 facility is needed in each area):

- Latrines and bathing facilities
- Small store for medication and material.
- Area for the preparation of chlorine solutions. (However to have 1 chlorine preparation point is more practical for both areas).
- Water collection points (e.g. water taps)
- Water point with 120 liter water buckets: 1 bucket for 0.5% chlorine solution and 1 bucket for 0.05% chlorine solutions
- Potable water (for patients) point: 120 liter water bucket or tap
- Hand washing point for patients
- Laundry area
- Shaded area for patients. (If possible close to outside fence to allow communication with relatives/friends that are outside the isolation facilities, but with double fencing or enough space to avoid physical contact or droplets transmission).

The following facilities should be made accessible for both areas (i.e. 1 facility is sufficient for both areas):

- Waste zone with burning area, sharps pit and organic waste pit. (Do not use existing ones, as they can't be reused after the outbreak is declared over.)
- Morgue.
- Spare building for possible supplementary facilities (delivery, paediatrics, recovery zone etc.)

#### **B. Low-risk zone**

- Laundry and drying area.
- Area for the preparation of chlorine solutions.
- Doctor's room: resting area and part of medical file papers will be stored here.
- Small pharmacy and store.
- Changing room to enter and exit Low-risk Zone.
- Changing room to enter and exit High-risk Zone.

#### **C. Outside the Marburg/Ebola ward (but close to isolation facilities)**

- Kitchen for patients. (E.g. kitchen from hospital can be used.)
- Latrine for staff.
- Psychological debriefing room for staff and patients families.

Different risk zones and their facilities:

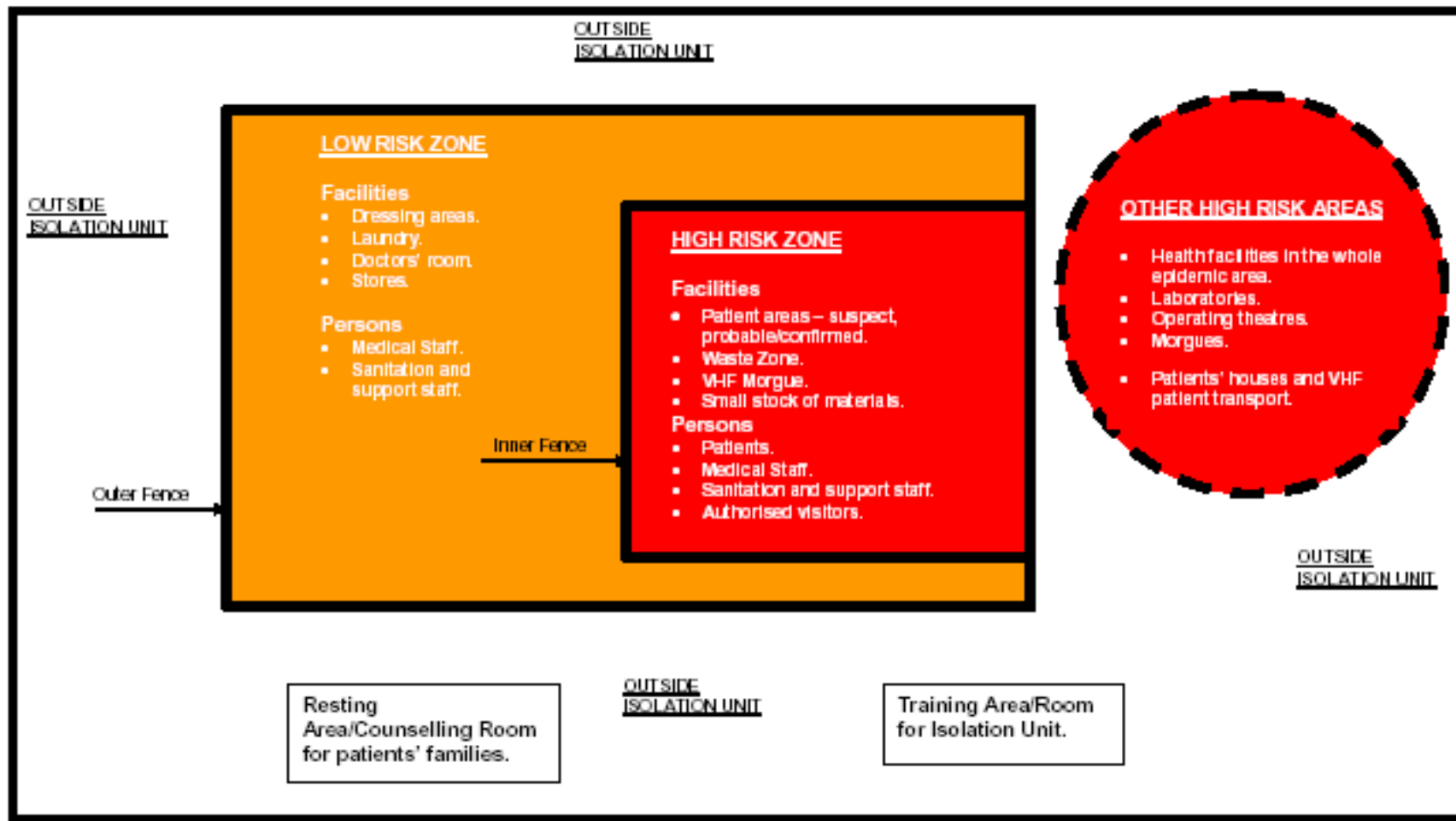

## **Fencing**

Fencing is important to mark the different risk zones. By clearly indicated borders between the risk zones the staff is aware of entering a different risk level.

- A fence should be put around the whole isolation facility to mark the borders between outside the isolation facility and inside the isolation facility. Use mesh fencing for transparency.
- Physically separate High-risk and Low-risk zones in the Marburg/Ebola unit by fencing or using existing walls to prevent uncontrolled movements between the zones.
- Different latrines, bathing facilities and stores should be created for suspected and confirmed patients to prevent cross infection between confirmed patients to negative suspect cases waiting for the lab results. Separation needs to be well indicated and understandable to prevent confusion amongst the patients and the staff.

## **Lay out of Marburg/Ebola unit**

See **Annex 9. Examples of lay out of Marburg/Ebola unit with different risk zones** for an example of a layout of an isolation facility with a theoretical design and an example of a design adapted to the situation in the setting and the caseload.

## **Entrance/exit points and disinfection**

Numbers of entrance/exit points should be limited to be able to control people going in and out and to ensure a proper disinfection.

Guards and disinfection points are needed at all entrance/exit points and the points need to be well accessible for cars.

- One entry/exit for entering the Low-risk area for staff and caregivers.
  - Hand washing and shoe spraying with 0.05% chlorine solution at entry and exit to avoid taking contamination into or outside the low risk area.
- Two entries/exits for entering/leaving the High-risk area:
  - One for staff and caregivers (via the Low-risk area) with sprayer and disinfection area.
  - One for patients directly entering/leaving the suspect area with sprayer/guard for disinfection when discharged patient leaves.
- One separate exit for dead bodies close to mortuary.

## **Changing rooms**

See **Annex 10. Example of plan of Changing Rooms**

Dressing and undressing must be done according to the protocols to prevent exposure to infectious material and to prevent infectious material being carried out of the isolation facilities.

Staff puts on and takes off protective clothing in specific changing rooms.

Two different changing rooms are necessary:

**Changing room 1** is located at the entrance to the Low-risk zone to take off normal clothing and change into basic protective clothing when entering the Low-risk zone and vice versa take off basic protective clothing and change into normal clothing when leaving the Low-risk zone.

Necessities for changing room 1:

- Clean scrub suits, boots and gloves in sufficient quantities and sizes available.
- Buckets or boxes to put dirty clothes in when changing.
- A division for men and women to change.
- Shelves or hangers to leave normal clothing.



**Changing room 2** is located at the entrance to the High-risk zone to put on and take off the additional PPE required in the High-risk zone. Necessities for changing room 2:

- Staff entering ('clean') and staff leaving ('dirty', potentially contaminated) the High-risk area should not interfere with each other.
- Entry path should be separated from the exit path to prevent cross contamination between 'dirty' people coming from the High-risk area and 'clean' people from the Low-risk area.
- The border between the different risk zones should be clearly indicated.
- Sufficient PPE with gloves in different sizes available.
- Mirrors and adequate lighting to check protective gear. When dressing best is to dress in pairs to be able to check each other when dressing.
- Disinfection point for staff leaving the High-risk area with sprayer and buckets with 0.5% and 0.05% chlorine solution and clean water to wipe off the chlorine of the goggles.

### **Staff, patient and material circuits**

The Marburg/Ebola unit should be organized in a way that a circuit prevents staff, patients and/or contaminated material from passing from the confirmed area to the suspect area, so that cross infections to patients admitted in the suspect area that turn out to be tested negative for FHF can be avoided:

- Suspected area and confirmed area should be visibly separated.
- Patients will be first admitted in the suspected area. If the lab result turns out to be positive, the patient will be moved to the confirmed area. Patients are not allowed to move in between the suspected and confirmed area unless directed.
- A footbath needs to be installed in between the suspect and confirmed area.
- Staff should always pass and work from the less contaminated area and patients (suspect area) to the more contaminated area (confirmed area). The entrance to the High-risk area should be close to the suspected area and the exit close to the confirmed cases area.
- Two separate ways should lead to the exit: 1 coming from the suspected area and 1 coming from the confirmed area. Install a 'one way' route so that mixing is not possible.
- Contaminated material should not pass from confirmed area to suspected area. Waste disposal should be reachable via separate ways from both the suspected area and the confirmed area.
- Both suspected and confirmed area need to have their own store and stock with drugs and material.

### **Footbaths**

Footbaths with 0.5% chlorine solution have as aim to get rid of the mud or soil on the boots to ensure proper disinfection and to prevent contaminated material being transported on boots from one area to the other. Footbaths should be placed:

- In between suspected and confirmed area
- At the disinfection points when leaving the High-risk area and leaving the Low-risk area.

### **Store, stock and supply**

A small stock of medicine and material is needed in the suspected area and the confirmed area. In the Low-risk area a bigger stock can be kept and supply can be quickly arranged if there is shortage in the High-risk area. The big stock should be kept in a store outside the Marburg/Ebola unit facilities. Enormous quantities of usage of PPE, chlorine etc. is expected in a FHF outbreak, so a good follow up of the stock is needed and orders to the capital/headquarters/other partners should be done in advance to ensure a proper and adequate supply.

### 3. Barrier nursing

The main purpose of barrier nursing and infection control is to prevent transmission of the virus. Barrier nursing means that a barrier is created between an infected patient and a non-infected person by using correctly the personal protective equipment (PPE).

#### **Personal Protective Equipment**

The purpose of PPE is to reduce the risk of becoming infected while working in a contaminated area, and to reduce to risk of carrying infected material out of the contaminated area by disinfecting and disposal of the PPE when leaving the High-risk area.

PPE protects the person wearing it. It should completely cover the body and leave no space open. The most vulnerable areas are the mucous membranes of the nose, mouth and eyes, and the hands as they are most frequently in direct contact with the patient.

When wearing the PPE and following the associated disinfection procedures, staff can be confident that it is safe to enter and work in the different risk zones. Nonetheless, prudent behavior and adherence to the disinfection procedures are essential in carrying out activities in a safe manner.

Although the purpose of the PPE is obvious, it is important to understand the function and purpose of the different elements used. A good understanding of the equipment will give confidence in its ability to protect and helps to ensure it is worn and used correctly.

PPE should be put on correctly before entry in the High-risk area, remains correctly in place while inside the High-risk area and removed safely when leaving the High-risk area.

Everybody must be responsible for themselves and for checking and monitoring their colleagues in wearing the PPE. The eyes, nose and mouth are the most vulnerable parts of the body. Particular attention is required to ensure that masks and goggles fit correctly and no space is left unprotected.

---

People wearing full protection gear can scare patients and the community.

---

#### ○ **PPE for visitors and patient's attendants**

Visitors and patient's attendants that will have no or limited contact can use an adapted set of protective clothing, that is easier and more comfortable. The adapted PPE should include mask or face shields, one pair of gloves, a gown and boots. Apron and head covers are not needed. Goggles are discussable, as wearing them is uncomfortable and people may touch the goggles thereby increasing the risk of getting infected. A competent staff member must supervise visitors while on the ward, explain the procedures to the visitors and assist them in dressing and undressing. However patient's attendants that will help to care of patients (e.g. parents of a sick child) will need to be dressed in complete PPE.

#### ○ **Dressing and undressing procedures**

Dressing and undressing must be done in a way that prevents the body being exposed to infectious material, this is especially important for the eye, nose and mouth. The order of removing contaminated clothing is critical. At the moment of writing the different experts did not yet come to a consensus about the best manner of undressing from the High-risk area.

Training how to undress should be given by the water/sanitation specialists in the outbreak and should follow the recommended undressing strategy at that moment. Once started with an undressing strategy, the strategy should not be changed anymore during that outbreak to avoid confusion. See **Annex 11. Dressing and undressing protocols.**

For PPE use and (un)dressing in High-risk areas outside the Marburg/Ebola unit see **Chapter 6.6.**

## **Explanation about the different PPE items and which PPE items to use in the different risk zones**

### **LOW RISK ZONE PPE**

In Changing room 1 staff removes personal clothes and put on:

#### **• Scrub suits and boots**

Personal clothes and shoes should not be worn under the PPE. Scrub suits and boots are used so that staff members do not use their personal clothing inside the isolation area. This reduces the risks that contaminated material could be carried outside the isolation area on people's personal clothing. Disposable examination gloves need to be put on. Scrub suits should be disinfected and washed after each use.

For identifying people once they are fully dressed, every staff member will need to have his/hers own boots, aprons and goggles with his/her name on it. Disinfected and dry boots should be available for all staff that needs to enter the Low-risk zone.

### **HIGH RISK ZONE PPE**

In Changing room 2 staff enters with Low risk zone protective clothes and put on:

#### **• Gown**

Gowns should cover the body completely and must be waterproof. Gowns are single use and disposable.

#### **• Gloves**

The hands are likely to become very contaminated and therefore gloves are essential.

Two pairs of gloves need to be worn:

○ 1st pair:

**Examination gloves** for all staff.

○ 2<sup>nd</sup> pair depends on the work that will be performed:

**Surgical gloves:** medical staff.

**Rubber cleaning gloves:** cleaning staff.

**Latex protection gloves:** waste handling, burial team.

Examination gloves and surgical gloves are single use and disposable. Cleaning gloves and protection gloves are reusable and need to be disinfected and washed.

#### **• High filtration masks**

Masks must be comfortable to wear and seal well the face. Their filtration capacity and an easy through-flow of air must be maintained. Masks are disposable.

#### **• Head covers**

Head covers should be waterproof and completely cover the head, hair, ears, neck and any part of the face not covered by the mask and the goggles. (If possible with shoulder flaps to provide an extra layer of protection by covering any gap at the collar of the gowns. Head covers are disposable.

#### **• Apron**

Plastic or rubber aprons provide extra protection of the front part of the body. Aprons need to be disinfected by the person wearing it, then hung to dry outside the changing room in the sun. They can be reused when dry. Every person should have his/hers own apron with their name and position on it to be able to be recognized when working in the High-risk area.

#### **• Goggles or face shields**

Goggles must fit comfortably and securely. Goggles need to be disinfected by the person wearing them, washed with water and then hung outside the changing room to dry. When dry the goggles can be reused. Every person should have his/hers own goggles with the name on them.

Condensation of the goggles can be a major problem: it impairs the user's vision and is dangerous. Anti-fog spray can minimize the condensation.

Face shields may be used by visitors. They are more comfortable and therefore safer to use. (Visitors should not touch the patient.)

## 4. Infection control measures

Infection control measures are essential to limit the risk of transmission of the virus.

### **Disinfection**

Soap, chlorine based products and UV from sunlight all destroy the FHF virus.

Chlorine is easy to use and active against all microorganisms.

Different percentages of chlorine solutions are used for different purposes. See **Annex 12**.

### **Preparation of chlorine solutions.**

#### **Remarks:**

- Chlorine solutions can weaken the second pair of gloves (surgical) and rubber household gloves. Gloves should be regularly checked for damage and the person wearing them should leave the High-risk area if they are broken. Rubber household gloves must be checked after cleaning, and before reuse.
- Wash gloved hands after each patient's contact.
- 12 liters sprayers, 1-liter hand sprayers and cups can be used as application method.
- Vigorous spraying of contaminated surfaces and corpses can create aerosols, therefore care is required and full protective gear must be worn!

**Table 4. Chlorine solution and their uses**

<b>Chlorine solution</b>	<b>Uses</b>
0.5%	Disinfection of: <ul style="list-style-type: none"><li>- Body fluids, excreta, vomit, etc.</li><li>- Corpses</li><li>- Toilets and bathrooms</li><li>- Gloved hands</li><li>- Floors</li><li>- Beds &amp; mattress covers</li></ul> Footbaths.
0.05%	Disinfection of: <ul style="list-style-type: none"><li>- Bare hands, skin and shoes.</li><li>- Thermometers.</li><li>- Laundry.</li><li>- Plates, cups and eating utensils.</li></ul>

#### ○ **Disinfection of patient's excreta, urine, vomit or blood:**

- Add 0.5% chlorine with a cup to the container to cover contents and discard in the latrine.
- Wash container with soapy water and discard in the latrine.
- Rinse container with 0.5% chlorine and the container is ready to be reused.
- Pour 0.5% chlorine solution with a cup on fluids on the floor (watch out for splashing) and cover fluids completely. (Sprayers should not be used to avoid formation of droplets.)
- Let stand for 15 minutes.
- Remove with rag or paper towels and discard in waste bin for infected waste.
- Wash area with water and soap.

## **Water: quantity, quality and storage**

### ○ **Water quantity**

Large quantities of water are required for the disinfection procedures, laundry of scrub suits and for general cleaning and hygiene. The water consumption depends mainly on the number of staff working in the isolation area and not on the number of patients. Approximately 70 l of water per day per staff member working in protective clothing should be calculated. Water is required for:

- Cleaning and laundry
- Hand washing (0.5% and 0.05% solutions) and footbaths
- Disinfection of PPE, materials, beds, mattresses, buildings, surfaces, etc.
- Disinfection and preparation of corpses.
- Drinking water and preparation of ORS.

### ○ **Water quality**

Clear water is required for drinking and the preparation of chlorine solutions.

- Turbidity < 5 NTU (if >20 NTU the water should be pretreated to remove turbidity and then chlorinated, see **MSF Guideline Public Health Engineering in emergency situation, 1994 first edition**).
- For drinking water the free residual chlorine at the tap should be between 0.3 and 0.5 mg/l.

### ○ **Water storage**

A 2 day consumption buffer is advisable, depending on the reliability of the water supply.

## **Sanitation: latrines, bathing and laundry**

### ○ **Latrines**

Suspect and confirmed cases should have separate latrines. Latrines/toilets in an existing structure should not be used, because once the outbreak is declared over the latrines will need to be backfilled. It is better to build pit latrines. Pit latrines are advisable, because they are easy to build and arrange according to the numbers of patients and the lay out of the unit and after the outbreak pit latrines can easily be back filled.

Minimum numbers of latrines is one latrine per 20 patients and preferably separate latrines for men and women should be built. Patients might be weak, therefore it is important to build the latrines in a way that patients can hold themselves or can sit.

### ○ **Bathing facilities**

Suspect and confirmed cases should have separate bathing facilities. The bathing facilities should be easy to clean and disinfect, and drain to a sealed soak-away. As for the toilets, it is important to build the bathing facilities adapted to weak people, i.e. with possibilities to hold one-self or to sit. Separate bathing facilities are needed for men and women.

### ○ **Laundry**

- **Protective clothing:** Reusable PPE that have been used in the isolation area are potentially contaminated and need to be disinfected and washed. See **Annex 13. Cleaning and disinfection of Protective Equipment**.
- **Bed linen and patient's clothing**  
Bed linen and patient's clothing should not leave the High-risk area. These items should be disinfected by soaking them in 0.05% chlorine solution for 30 min, and then washed and air-dried. Heavily soiled items should be soaked in 0.05% chlorine solution overnight and then burned the following day. Clothes and bed linen of deceased patients should be buried with the corpse or they should be burned.

### **Waste management**

All waste from the isolation area is considered highly contaminated. Waste must be safely collected, handled, transported to and disposed of in a secure location inside the High-risk zone.

Staff involved in the management of waste must wear full protective gear. Waste can be divided into burnable waste, liquid waste, organic waste, sharps and waste-water. See **Annex 14. Waste management: waste definitions, collection, transport and disposal**

In each ward the following items should be available:

- sharp containers
- buckets for liquid waste
- rubbish bins for solid waste.

In the High-risk area the following waste disposal need to be created:

- a burning area
- organic waste pit
- sharps pit.

Liquid waste can be disposed in a pit latrine.

## **5. Home Based Support and Risk Reduction (HBSRR)**

The best approach to control and to stop a FHF outbreak is to isolate the patients in a Marburg/Ebola unit. A well functioning Marburg/Ebola unit allows medical and nursing care to be provided in a safe environment, provides protection for the families and the community and it will contribute in breaking the transmission routes.

However, when a patient, the family or the community continuously refuses admission in the Marburg/Ebola unit or if for other reasons admission is not possible, then an alternative approach must be considered even if the alternative is far from perfect.

HBSRR is an alternative approach where the patient remains at home and is looked after by one designated caregiver. Protective equipment and disinfection materials are provided, training is given and a daily follow up by a mobile team is organized.

HBSRR can't replace health-structure based patient management in terms of quality medical care or safety. Instead, it reduces the risk of disease transmission when care and isolation in a Marburg/Ebola unit is refused.

HBSRR can help to gain trust and might be a temporary solution. After some days the patient and relatives may accept to admit the patient into the Marburg/Ebola unit, as seen in previous outbreaks.<sup>3</sup>

Continuously try to encourage acceptance of the Marburg/Ebola Unit by using the following arguments:

- In the HBSRR there is the risk that the patient will infect other people, while there is hardly any risk in the Marburg/Ebola Unit.
- Family members can always come to visit the patient in the Marburg/Ebola unit.
- Best medical care can be provided in the Marburg/Ebola Unit, like IV fluids and injections, and nurses and doctors are always available to provide care. In the HBSRR only ORS and tablets can be given.

### **HBSRR procedures**

- A medical person, a watsan person and a psychologist/health promoter are needed to initiate the HBSRR.
- Daily follow up (if possible according human resources and geography) is needed by a medical person to supervise the caregiver when taking care of the patient and to follow the situation of the patient.
- Only 1 family member will be allowed to care for the patient for the entire duration of the patient's illness, to minimize the number of people at risk of exposure. This caregiver will need to be trained about FHF, the PPE, the dressing/undressing procedures and disinfection.
- Reduced protective clothing can be used as described for visitors in the Marburg/Ebola unit.
- Every day sufficient PPE and material should be provided.
- Identify an area/room in the family compound with a separate entrance where the patient will be accommodated. If possible fence this area.
- A separate latrine should be available or made. If this is not possible the patient can use a bucket containing 0.5% chlorine, which can be transferred to the family's latrine.
- A 1 m deep pit needs to be dug for disposal and burning of waste, inclusive the disposable PPE material .
- 2 collapsible containers (20 liters) with tap should be installed with 0.5% and 0.05% chlorine solution and the caretaker should be explained and supervised how to use it.
- Explain the caretaker how to:
  - o Give the drugs to the patient
  - o Feed and wash the patient
  - o Disinfect and dispose of feces and any spills
  - o Disinfect and wash clothing, the bed, bed sheets, etc.
- Ensure the patient has his own utensils: cup, plate and spoon.
- After the set up and initiation of the HBSRR, the MSF staff will try to avoid entering the HBSRR unit and the designated caregiver will be the only person entering the room.
- See **Annex 15. Caretaker Task instructions HBSRR and HBSRR kit**

### **Key points**

- FHF patients need to be isolated to avoid infecting other people
- Health promotion activities and an 'open' set up of the Marburg/Ebola unit will help to increase community acceptance of the isolation
- Barrier nursing is required and staff will need to wear PPE
- The Marburg/Ebola unit consists of a High-risk and a Low-risk area
- Suspect and confirmed patients need to be cared for separately.
- Infection control activities are essential to limit the risk of transmission of the virus: disinfection procedures, sanitation and waste management
- Home Based Support and Risk Reduction is an alternative, but less satisfactory approach when admission in the Marburg/Ebola unit is refused.

# Chapter 5. Patient care

## 1. Medical staff for Marburg/Ebola unit

Medical and nursing care should be provided 24 hrs per day.

- Shifts of, for example, 8 hrs can be organized. Adequate rest needs to be taken after shifts, e.g. one day morning shift, next day afternoon shift, then night shift, then 2 days off, etc.
- During each shift 2-3 breaks need to be taken. It might be difficult to spend long periods in the High-Risk zone when it is hot. The staff should undress and go out of the High-risk area when having a break.
- 4 Teams can be formed: 1 team for each shift and 1 off.
- Each team should contain 1 (national) medical doctor or clinical officer and 2-4 nurses, depending on the amount of patients admitted and the available human resources. It is advisable to work in couples for a good collaboration and to supervise each other.
- An expatriate nurse and doctor should supervise and train the staff. When the first night shifts are introduced, it is advisable for a medical expatriate to be present to check the safety circumstances and to supervise the activities.

## 2. Admission

Admission should be possible 24 hrs around the clock (a medical doctor or clinical officer will always be on call). All identified suspect or probable cases need to be admitted in the suspected or probable area until laboratory results are known or clinical discharge criteria are reached (in absence of a lab).

The following activities need to be done on admission:

- Explanation needs to be given to the patient and the patient's attendant about the reason of admission, the procedures and rules in the Ebola/Marburg unit, the location of toilets and showers and the visiting hours.
- An information paper (See **Annex 16. Information for patients, discharged patients and relatives**) for patients and one for the patient's attendant should be read and explained.
- All material will be provided from inside the Marburg/Ebola ward to the patients. Items given from outside to the patient may need to be destroyed and this should be well explained to the patient and relatives. Under supervision it is allowed to bring food from home to the patient.
- A bed in the suspected area needs to be prepared and indicated to the patient.
- Different items need to be given to the patient like mattress, blanket, cup, plate, soap, etc. See **Annex 17. List for patient items provided at admission**. These items must not be shared in between patients.
- Creation of a personal medical file containing:
  - **Medical admission and epidemiological form** (See **Annex 18.2**)  
Best is to fill this form in outside the High-risk area and it can remain and filed in the medical room in the Low-risk area.
  - **Observation sheet** – Symptomatology and Vital signs (See **Annex 18.3**) needs to be started on day of admission and continued during the whole period of stay. Two forms should be filled in: 1 stays in the High-risk area and 1 in the medical room in the Low-risk area.
  - **Treatment sheet** (See **Annex 18.3**) needs to be filled in with the prescribed treatment by the doctor in charge. Also 1 sheet inside and 1 outside High-risk area.
- Psychosocial support (by psychologist) needs to be provided or planned.



### 3. Laboratory tests

A lab test needs to be performed if possible on the day of admission. Samples should only be taken for diagnostic purposes and sometimes to help in discharge decisions. Discharge decisions are taken on clinical grounds, but in some cases sample results might help in taking the decision. Sample taking is a high-risk procedure. When taking a sample prudent behavior and concentration is essential. See **Invasive procedures**.

---

PPE doesn't protect a person from a needle stick incident.

---

If the result is negative and the sample is taken between day 0-3 after onset of symptoms, the test should be repeated, because sometimes a low viremia at the start of symptoms might give a negative test result. The second sample needs to be taken on a day more than 3 days after start of symptoms. Also sometimes a clinically obvious case might have a negative laboratory result due to reverse transcriptase inhibitors present in the blood. (Discuss these cases with the laboratory staff and keep the patients in the Marburg/Ebola unit.) See **Annex 5. Laboratory tests**.

If the test is positive for FHF the patient will need to be transferred to the confirmed area and the area where the patient was accommodated in the suspected ward need to be disinfected.

### 4. Medical care

---

After attending each patient the gloved hands should be washed with 0.5% chlorine solution to prevent spread of infections between patients.

---

Currently there is no curative treatment for Ebola and Marburg Haemorrhagic Fever. Only supportive treatment can be offered to the patients. However experience in former outbreaks shows that supportive treatment reduces the suffering of the patients and aggressive invasive supportive treatment might maximize chances of survival.<sup>4</sup> Because outbreaks are rare and medical information is lacking, detailed data collection on treatment given and treatment outcome needs to be gathered to gain a better understanding and more information about the effects of the different supportive therapies. Experimental treatments with different types of drugs or vaccines may be considered for testing during an outbreak, if no harm for the patient can be expected and ethical standards are up-held.<sup>5</sup>

---

**Experimental therapies for research purposes need to be done with approval of headquarters and the appropriate national authorities.**

---

**Remark:**

*Medical equipment for physical examination like blood pressure machines and stethoscopes are difficult to use due to the barrier created by the protective clothing. Moreover the disinfecting procedures needed after each use, with chlorine solutions will destroy the material and reduce the reliability of the equipment. No digital thermometers should be used. If only digital thermometers are available, each patient should have his own and after discharge or death, the thermometer should be destroyed.*

Different levels of supportive treatment may be provided depending on the safety conditions in the isolation ward. Providing basic oral medication and rehydration solutions is easy and involves minimal risk for staff and patients.

### **Invasive procedures**

A higher level of supportive care has a possible positive effect on clinical outcome. However invasive procedures like injected drugs, IV fluids and NG tubes are potentially dangerous for the ones performing them and should only be performed when the required safety conditions are achieved. Open discussion with the staff are needed to assure that those performing procedures understand the risks and are comfortable to do the procedures.

#### **Safety conditions for invasive procedures:**

- Availability of skilled, experienced and well trained staff
- Adequate infection control
- Sufficient lighting
- 2 people should perform the invasive procedure: one actually performing the procedure and the other assisting in handing out material and controlling the patient.
- Patients should be properly positioned.
- Sharp box and all material needed should be taken to the bedside.
- Inserted canulas should be well secured to avoid being pulled out by the patient, resulting in spreading contaminated blood.
- Plastic canulas should be used for IV infusions. Metal needles and butterflies should only be used for injections and not for drips, given the hazard they pose.
- No risk should be taken with aggressive or confused patients. Tranquillizers should be given to them before performing dangerous procedures or such procedures should be avoided.
- No invasive care should be provided to a patient where a non-invasive alternative is equally effective, e.g. there is no need for injectable medication if oral medication is sufficient.
- If injected treatments are given, medicines with long half-lives should be chosen to minimize the number of injections that need to be given (e.g. ceftriaxone).

---

Each invasive procedure is a dangerous action for the person performing the procedure and his assistant. Therefore limit the invasive procedures to the absolutely necessary, but keep in mind that intensive supportive treatment may have a positive impact on the outcome.

---

### **Hydration**

#### **A. Oral hydration**

Ebola and Marburg provoke gastro-intestinal symptoms such as watery diarrhea, vomiting and anorexia, as well as causing fever. This may result in severe dehydration.

Oral Rehydration Solution (ORS) should be provided to patients able to drink and support needs to be given to weak patients. Patients with light vomiting should be put on anti-emetics.

#### **B. IV hydration**

Patients with insufficient oral intake, severe diarrhea or vomiting (insufficient input for increased output) or paralytic ileus should start IV hydration.

Perfusion rate and quantity of fluid depend on the grade of dehydration. Patients need to be monitored for signs of over-hydration resulting in pulmonary edema e.g. engorged jugular veins, tachypnoea or tachycardia.

#### ***Remark:***

*In case of shock cristalloids should be used. Colloids should be banned as it may affect blood clotting and evidence of superiority of colloids over cristalloids is lacking in patients with shock.*

### **Symptomatic care**

FHF infections often provoke a painful throat and difficulty in swallowing. Therefore the amount of tablets to be swallowed should be as low as possible and the size of the tablets as small as possible. Also tablets may be crushed.

#### **A. Anti-pyretics**

Fever is a common feature in Ebola and Marburg infections and paracetamol can be given to reduce the temperature and the pain.

#### **Remark:**

*Aspirin and other non-steroidal anti-inflammatories should not be used due to their effect on blood clotting.*

#### **B. Pain control**

Pains caused by filovirus infections, like headache, abdominal pains and joint pains are often severe. Adequate painkillers can reduce the suffering of the patients.

<b>Pain level</b>	<b>Medication</b>	<b>Dosing</b>
<b>Mild pain</b>	Paracetamol	Adults: 1 g PO 6 hrs PRN, max 4 g/24 hr Children: 15 mg/kg
<b>Moderate pain</b>	Tramadol	Adults: 50-100mg PO/IM/slow IV 4-6 hrs PRN Children: do not use < 15 yrs
<b>Severe pain</b>	Morphine	Children and adults: 0.1 mg/kg SC 4hrs PRN

#### **Remarks:**

- *There is interaction between tramadol and morphine, so these medications should not be given simultaneously. Morphine may be combined with codeine.*
- *Non-steroid-anti-inflammatory drugs (NSAIDS) should not be given due to their inhibition of platelet aggregation and the risk of peptic ulcers.*

#### **C. Nausea, vomiting and dyspepsia**

Nausea and vomiting are common. Anti-emetics like promethazine or metoclopramide can be used. Filoviruses often provoke stomach pain and dyspepsia. Dyspepsia can be treated with cimetidine, ranitidine or omeprazole.

<b>Medication</b>	<b>Dosage adults</b>	<b>Dosage children 2-10 yrs</b>
<b>Promethazine</b>	25-50mg PO every 6hrs PRN	10-25mg PO every 6 hrs PRN
<b>Metoclopramide</b>	10 mg PO/IM/slow IV every 6-8 hrs	2-5 mg PO/IM/slow IV every 8 hrs
<b>Cimetidine</b>	200-400 mg OD	

#### **D. Anxiety**

Anxiety is common. Psychologists can help to reduce anxiety. Diazepam (e.g. 5mg PO TDS) might be given to manage severe anxiety.

#### **E. Agitation and confusion**

Patients can get agitated, confused or aggressive and can be a danger to themselves and others. Tranquillizers like chlorpromazine or diazepam can be given.

Medicine	Adult dosage	Children dosage	Remarks
<b>Chlorpromazine</b>	25-50 mg IV/IV/ PO every 8 hrs PRN (half dosage in elderly patients)	0.5mg/kg PRN	Further doses may be needed, but wait minimum 20 minutes before next application.
<b>Diazepam</b>	5-10mg IM PRN, not repeated within 1 hr	0.3 mg/kg IV	

**Remark:**

*Stop the usage of chlorpromazin if sudden raise of temperature occurs: possible neuroleptic malignant syndrome (this is an uncommon, but serious event when using chlorpromazine)*

**Presumptive treatment**

Symptoms of Marburg and Ebola infections are similar to those of common diseases in the areas where the FHF outbreaks normally occur e.g. malaria, typhoid or shigellosis.

Patients with Ebola or Marburg infections may suffer from common diseases at the same time that can interfere with their ability to build an immune response to the filovirus infection.

Also a patient with a common tropical disease can be admitted as suspected FHF case and appropriate treatment should not be delayed until the lab results of FHF are known.

To avoid leaving these common tropical diseases untreated in suspected FHF patients, systematic treatment with appropriate antibiotics and anti-malarial treatment should be provided to all suspected patients on admission.

**Remark:**

- *Sometimes a field laboratory with Biosafety 4 level will be available. Then malaria and different pathologies might be able to be tested and treatment can be adapted according to results.*
- *The systematic treatment needs to be used in a flexible way and can't replace the clinician's judgment.*

**A. Broad spectrum antibiotics**

A broad-spectrum antibiotic with oral cefixime or injectable ceftriaxone should be given starting from the day of admission to cover the wide range of pathologies. For penicillin allergic patients azithromycin can be prescribed. (Amoxicillin and cotrimoxazol might not be strong enough). Duration should be minimum 5 days, but may be continued during the whole length of stay to keep the patient covered, depending on the clinician's point of view. However, the clinician should prescribe antibiotics always according to the presentation and severity of the symptoms, and according to concomitant epidemics.

**B. Anti-malarials**

A full regime of anti-malarial treatment should be given on admission according to the anti-malarial protocol used. Amodiaquine and fansidar should be avoided because of its effect on the liver. Coartem can be given safely according to the current protocol, but has many drug interactions.

**Remark:**

*Coartem can't be given simultaneously with ciprofloxacin, cimetidine, macrolides like erythromycin or anti-psychotics like chlorpromazine.*

### **Supplementation**

Vitamin deficiencies may have a negative influence on the immune reaction of the patient to the virus and should be corrected. Vitamin A, B, C or multivitamins can be beneficial to the patients.

<b>Type of Vitamin</b>	<b>Dosage adults</b>	<b>Dosage children</b>
<b>Vitamin A (Retinol)</b>	200.000 IU PO on day 1,2 and 8	100.000 IU PO on day 1, 2 and 8 (children between 6m-1yr)
<b>Vitamin B (Vit.B complex)</b>	1 tab per day	1 tab per day
<b>Vitamin C (Ascorbic acid)</b>	250-500mg PO 3times/day	125-250 mg 3times/day
<b>Multivitamin</b>	1 tab per day	1 tab per day

### **Nutritional support**

#### **Procedures to provide food**

Food needs to be provided by the hospital or MSF, as some patients will not have family to provide food. Food should be carried with containers that are locally used for the transport of human food from outside the isolation facilities to the High-risk area where it will be transferred in empty containers inside the High-risk area **without contact** between the containers. In the High-risk area it will be divided for the Suspected area and the Confirmed area. Some food should be kept in the Low-risk area for the caregivers.

Families should also be allowed to provide food for their relatives, as this food is likely to be more acceptable by the patients. Family can provide food to the patient ‘over the fence’ of the High-risk area under supervision of the staff, and no items should be taken inside the High-risk area.

Plates inside the High-risk area need to be disinfected and washed first before food can be received. Help needs to be given to patients who are not able to eat independently.

#### **Type of food**

FHF infections can provoke anorexia, vomiting and difficulty in swallowing. Inappropriate feeding can contribute to an ineffective immune response to the filovirus infection. Food should be easy to digest, well balanced and culturally acceptable.

The patient should be encouraged to take Plumpynut, besides the food provided by the hospital, MSF or the family. Alternatively porridge can be offered because it is easy to swallow.

NG tube feeding can be considered in severe feeding problems.

## **5. Nursing care**

Nurses, rather than family members, should provide all basic nursing care, to reduce the risk of transmission. However often in the beginning of an outbreak there might not be sufficient nursing staff employed and then family members may be needed to help providing care like feeding. These family members must be instructed and supervised and protective clothing should be given.

---

Relatives involved in basic nursing care will be considered as a contact and will need to be followed up for 21 days after their last visit to the Marburg/Ebola unit.

---

Nursing tasks (to be adapted to the available human resources and work load):

- Patient monitoring:
  - o Temperature check three times daily
  - o Observation for symptoms that need to be mentioned during the doctor's round.
- Medication: (Separate stocks are needed for suspected and confirmed patients.)  
Medication should be provided according to doctor's prescription and crossed after the patient's intake.
- Call the doctor in case of any medical problem
- Provide food, water and ORS and assists where needed and registers quantities.
- Hygiene: help bathing in shower or in the bed and ensure clean bed linen for patient.
- Explain what you are doing and why to the patient.

## 6. Psychological support

Psychological support should be offered to all patients and families, ideally from the beginning of the intervention. However providing psychological care in PPE might be uncomfortable and difficult: The PPE is physically exhausting for the psychologist and for the patient it is impossible to see the face of the psychologist (seeing faces helps to establish a good contact). For mobile patients an area can be created where the patients can talk over the fence of the High-risk area with the psychologist at sufficient distance to prevent contamination.

## 7. Children in the Marburg/Ebola unit

Providing 24-hour care and psychological support for babies and small children is difficult in full protective clothing. The staff should provide the care as much as possible. However, for the well being of both children and parents, parents should be permitted to stay in the Marburg/Ebola unit to care for their children.

Protective clothing should be provided and supervised by the staff in the Marburg/Ebola unit. Parents/caregivers should take regular breaks and leave the Marburg/Ebola unit, e.g. at times when there is food for them available in the Low-risk area. Ideally one person should take care of the child to minimize the number of people at risk of infection, but it might be decided that more caretakers will care for the child during the admission time. All caregivers will need to be followed up as contacts.

### Mothers with breastfeeding children

There is a high risk that mothers with FHF infection will infect their children. Therefore precautions to minimize this risk must be taken:

- **Stop breastfeeding immediately** and provide artificial milk or plumpynut (if child is  $\geq 6$  months). Continue stimulation of milk production and relieve breast congestion with a breast milk pump. (Included in the MSF standard Hemorrhagic fever kit).
- Separate child from the mother and close monitoring is needed for 21 days. Child is seen as a close contact. Discourage breastfeeding from another women (wet-nursing).

## 8. Maternity and FHF

Obstetric patients pose special problems in an outbreak:

- Vaginal bleeding is a common symptom and obstetric patients are likely to fit the alert or suspected case definition for FHF.
- Patients with FHF are likely to abort or to miscarry and have a very poor prognosis.

During a FHF outbreak it is difficult to differentiate between a 'normal' spontaneous abortion/miscarriage or one induced by the FHF virus on clinical grounds alone; a blood sample will help with the diagnosis. Full term deliveries are rare in a Marburg/Ebola unit, but basic facilities for deliveries and a private area to conduct them should be installed if possible.

## 9. Discharge

### Discharge criteria

The decision to discharge a patient should be taken on clinical grounds, but can be supported by the laboratory results. A negative PCR means that the virus can't be detected anymore in the body and the patient is unlikely to be contagious. Patients can be discharged if they meet all following clinical criteria:

#### ○ **Clinical criteria:**

- 3 days without fever or significant symptoms AND
- A significant improvement in clinical condition AND
- Able to feed, wash and walk independently.

#### ○ **Laboratory support:**

- Antigen or PCR is negative on day 4 or later after the onset of the symptoms OR
- PCR turned negative after having been positive AND patient is clinically cured OR
- If patient suffers symptoms, but these are not thought to be due to FHF, 2 negative blood PCR's 48 hrs apart can be used as discharge criteria. The patient might be referred to another ward.

---

Fever can be absent in late and terminal stages of the illness and is not a reliable sign for discharge (or admission). Absence of fever cannot be used alone to plan discharges.

---

### Discharge procedures

#### **Disinfection**

On discharge all clothes should be disinfected by soaking them for 30 min in an 0.05% chlorine solution, then wash with soap, rinse with water and then air-dry. Severely dirty clothes should be burnt. It is useful when replacement clothing brought by family members is available.

All discharged patients should take a shower with 0.05% chlorine solution and put on his/hers replacement or clean clothes and avoid any contact with items in the Marburg/Ebola ward.

Disinfect and return other belongings to the patient. The patient can go to the patient exit where hands and feet will be sprayed. The hospital belongings like bed, mattress (with plastic protection) and buckets need to be disinfected and may be reused by another patient. Sheets should be burned and eating utensils thrown away.

### **Solidarity kit**

A solidarity kit should be provided to patients at discharge and to relatives of a deceased person. It is likely that patient's clothes and belongings have been destroyed upon discharge or through disinfection activities at their home. A 'discharge kit' with common belongings, clothes and some extra items should be provided (by MSF) to compensate for the lost. **(See Annex 19. Solidarity kit)** Patients that were temporary isolated in the suspected area, but turned out to be negative, should only receive items that have been destroyed during their presence in the ward.

### **Accompany patient to his/her home**

Rejection of patients by their communities is a common phenomenon in FHF outbreaks. A medical person or a health promoter or a psychologist should accompany patients on their way home and it should be well explained to the family and the community that they are not contagious anymore and that touching them is not a problem.

### **Supportive treatment and follow up**

Convalescent patients will be weak for some weeks or months and additional help can be provided:

- Provide 1-2 month supply of vitamin supplements.
- Provide Plumpy nut as additional food to the normal food for 1 month.  
(Flexible time period; depending on severity of weakness and poverty of family)
- Provide condoms for 3 months to all male discharged patients and explain the purpose. The virus can be found in the semen up to 3 months after onset of disease, so theoretically infecting other people is possible.

Regular visits are recommendable to follow the recovery, to see if additional supportive or psychological help is needed and to help integration into the community.

## **10. Patient care in the Home Based Support and Risk Reduction**

The designated caregiver will be the person entering the HBSRR after a proper training is given. The medical person might accompany the caregiver when entering the HBSRR on the daily visits, however sometimes daily visits can not be assured (workload, distances, etc.) See **Annex 15.**

**Caregiver task instruction HBSRR and HBSRR Kit.**

### **Laboratory tests**

If possible laboratory tests for confirmation should be taken in the Home Based Support and Risk Reduction. Use of PPE is compulsory and sufficient light should be there when taking the sample.

### **Medical file**

A medical file should be created as for patients admitted in the Marburg/Ebola Unit with: Triage form, admission and epidemiological form, observation sheet and treatment sheet  
See **Annex 18. Medical and Epidemiological forms**

### **Treatment**

No injected treatment can be provided (no ensured sufficient lighting, no continuous follow up, etc) but painkillers, oral antibiotics, anti-malarials and ORS can be given by the caretaker.



### **Admission and discharge criteria**

Admission and discharge criteria are similar to the patients admitted in the Marburg/Ebola Unit.

### **Psychological support**

Psychological support should be provided to the patient, family members and the community. The psychologist can also play a role in trying to convince the people off transport to and admission into the Marburg/Ebola unit.

### **Key points**

- Medical care, nursing care and psychological support may increase chances of survival and can reduce suffering.
- To date supportive treatment is the only treatment available for FHF patients: hydration therapy, symptomatic care, presumptive treatment, supplementation and nutritional support
- Discharge is based on clinical criteria, and can be supported by laboratory results.
- On discharge, patients and items need to be disinfected and the patient will be accompanied home.
- A solidarity kit should be provided to discharged patients and to the relatives of a deceased patient.
- Discharged patients need to receive supportive treatment and be followed up
- Patient care that can be provided in HBSRR is limited compared to patient care possibilities in the Marburg/Ebola unit.

## Chapter 6. Surveillance system for case detection and safe transportation

---

Considering the infectivity and high case fatality rate, early detection and immediate isolation of new cases will limit new chains of transmission and will have a significant impact on control of the epidemic.

---

A proactive approach in case detection will demand major inputs of time and human resources, especially in large and geographically dispersed outbreaks. Moreover, accessibility is often a problem in the areas where outbreaks occur (mountainous areas, tropical rainforest regions without roads for cars, etc.). Collaboration between different partners is important to use the different capacities of each partner. For an efficient surveillance system, it is important to have a trusting relationship with the community to obtain an optimum collaboration. The acceptance of being taken to the Marburg/Ebola ward or to alert a case to the surveillance team all depends on the confidence of the community in the intervention and the health facilities. The teams must be trained to work in diplomatic and empathetic manner that facilitates developing good relations with the communities.

Health promotion is one of the priority activities to start with in an intervention.

The following surveillance strategies need to be carried out:

- **Contact tracing and contact follow up**
- **Rumor checking**
- **Ambulance service**
- **Triage in health facilities**

Different teams will be needed, but activities of the teams may be combined, e.g. the rumor checking team may also be the ambulance team or the contact tracing team may also check the rumors, etc. This depends on the magnitude of the outbreak, the available human resources and the distances between the cases.

### 1. Contact tracing and follow up

Tracing and follow up of people who have had contact with suspect, probable or confirmed cases is a proactive and valuable strategy for identification of new cases. See **Annex 3.B Suggested case definitions – Contact person** for definition of a contact person. However, it is an extensive and laborious intervention: on average for each case, 10-12 contact people have to be followed during the potential incubation period, counted from the last day of contact with the case.

When a suspect is identified, contacts should be traced and follow up should be started. If the laboratory test turns out to be negative, the follow up can be stopped. If the laboratory test is positive, contact should be followed during 21 days.

#### **Activities:**

Team: Driver, Community Health Workers (CHW) and a medical supervisor.

- Fill out a Contact Tracing Form (**See Annex 18.4 Contact Tracing Form**) for each contact and keep all forms in a central place.
- Monitor the contact daily for general symptoms and check temperature:  
A contact becomes a suspect case, when fitting in the case definition for suspect case. See **Annex 3.B. Suggested Case definitions**)

- If a suspect is found the ambulance team need to be called to transport the suspect to the Marburg/Ebola ward for assessment and possibly sample taking and admission in the suspected area. The patient shouldn't be in contact with anybody until the ambulance team arrives.

---

During FHF outbreaks patients often deny having symptoms out of fear and therefore the temperature is the only objective measurement for suspect case identification.

---

## 2. Rumor checking

Rumors about alert cases (**See Annex 3.B Suggested case definitions**) can reach the surveillance system by different manners:

- Rumors mentioned by the community to the Community Health Workers during contact tracing/follow up activities or Health promotion activities.
- Spontaneously by the community to expatriate/national staff working in an outbreak.

Alerts may be numerous and the right information needs to be gathered before the rumor checking team will go to see the case. A focus person can be pointed out to collect all alerts, verify if the symptoms fit in the alert case definition, and makes sure that relevant information is noted before alerting the Rumor checking team: e.g. the name of the alert case, name of the person raising the alert, (sub) village, symptoms and contact history.

If a patient died at home, a medical person (outreach doctor or nurse) should take the clinical history from the family. If there is a suspicion that the person could have died from FHF, then the burial team needs to be alerted to perform safe burial practices. See **Chapter 7.4 Community deaths**.

### Activities:

Team: 1 driver, 1 medical person and 1 sprayer with 1 spraying machine

- Each alert needs to be checked by a medical person that decides if an alert case is a suspected case and needs to be taken to the Marburg/Ebola ward.
- A triage form should be filled in for each rumor. **See Annex 18.1. Triage form.** All positive and negative triage forms should be kept and outcomes registered in a Rumor Registration Book.
- Sometimes an alert case can be re-assessed by the rumor checking team, CHW or health centre staff for 1 or more days when the alert doesn't completely fit the suspected case definition, but when there is doubt if the symptoms might develop into those of a suspect case.
- If the alert is identified as a suspect case, then the ambulance team needs to be alerted to transport the patient to the Marburg/Ebola unit for assessment and possibly sample taking and admission in the suspected area. The patient should not be in contact with anybody until the ambulance team arrives.
- Rumor checking when a death occurs in the community.
- Always take drugs with you in case another disease is suspected, e.g. anti-malarials, antibiotics and paracetamol.
- **See Annex 20. Supplies for Rumor Checking Team** what to take with you. Take 3 full PPE clothing with you: for the medical person, the sprayer and 1 spare.

### 3. Ambulance service and safe transport

When a suspect case is identified he/she must be transferred to the Marburg/Ebola ward.

To prevent contamination and spreading of infection patients need to be transported in a safe way.

A pick-up car with a closed (or open) back is the most practical to use:

- Patients can be transported separately from the transporting staff
- Patient is not visible during transport.
- The outside is easy to disinfect.

A normal car (hard top) should not be used, as separation needs to be made between the staff and the patient and the disinfection with chlorine solution will damage the inside of the car.

The decision to take a person to Marburg/Ebola ward often leads to highly emotional and tense situations. Communication about the reasons and the procedures to the family and the community is extremely important to avoid misunderstandings and mistrust. A health promoter or psychologist might be useful as part of the team to take time to communicate with the surrounding people.

#### Activities

Team: 1 driver, 1 expatriate watsan or medical person (should have received training by a watsan about the safety procedures if going without watsan), 2 sprayers, 1 health promoter/psychologist.

- Transportation of suspect cases to the Marburg/Ebola unit in a safe way.
- Spraying of the place where the patient was accommodated.
- Spraying of the back of the pick up where the patient was seated.
- Material to take with you: **See Annex 21. Supplies for Ambulance Teams**

Take 5 PPE with you: 1 for watsan/medical person, 2 sprayers, 1 for the caretaker and 1 spare one.

#### Procedures when transporting the patient to the Marburg/Ebola unit

Take the following items with you (**See Annex 21**):

- 2 spraying machines: one for the sprayer dressed up and one for the sprayer undressed.
  - A mattress with plastic cover to put at the back of the pick up where the patient can lay or sit on during the transport.
  - Take stretcher to transport patient to the car and from the car to the Marburg/Ebola ward in case the patient can't walk.
  - Something that is easy to disinfect on which the patient can step to facilitate to step into the back of the car if the patient can walk.
  - A bucket with a small amount of a prepared 0.5% solution can be taken at the back of the car in case there is a history of vomiting.
- The driver and the health promoter/psychologist should not be close to the patient and don't need to put on PPE protective clothes. They should be dressed in normal clothes to be as 'normal' and accessible for the population as possible. Explanation will be given to the community about the different steps to take in transporting the patient to the ward.
  - One caregiver can be allowed to support the patient during the transport and should stay on the back of the car with the patient. This person needs to wear protective clothes for caretakers. (See Chapter 4.3 PPE for visitors and patient's attendants.

**There are 2 ways of transporting the patient:**

**1. The patient is mobile and can walk alone**

The patient will be instructed to take place in the back of the pick up. There is no need for the Rumor checking team to dress up if the patient will not be touched and they keep a distance. When touching anything touched by the patient, for example when closing the back of the pick-up, examination gloves should be used and these should be sprayed before removal and disposed of safely (take to the High-risk area to be burned.)

**2. The patient is too weak to walk and needs to be transported with the stretcher**

Two people should get dressed up, put the patient on the stretcher and put in the back of the car, together with the caretaker. Dressing and undressing should take place in front of the community in a transparent way. If the patient is heavy, more people need to dress up.

**Spraying of the house**

The house where the patient lived when he/she was sick needs to be sprayed. The ambulance team can spray the house (See **Chapter 7.1 Home spraying**) before transporting the patient to the Marburg/Ebola unit or the burial/spraying team can be called. If the house can't be sprayed immediately then the door of the house needs to be locked and no one is allowed to enter the house until the arrival of the Spraying Team. It is advisable to spray the houses of all suspects immediately. Exceptions can be made if laboratory results can be expected quickly (e.g. < 1 day) and if the house can be locked when waiting for the results.

**Arrival at the Marburg/Ebola unit**

The ambulance should inform the Marburg/Ebola unit that they will arrive with a patient. The pick-up should drive up to the patient's entrance of the Marburg/Ebola ward. The ambulance team should not dress up again, but the staff of the Marburg/Ebola unit should take care of the transport from the car to the ward. The staff of the Marburg/Ebola unit should dress in PPE, leave the High-risk area at the patients entrance/exit, should be sprayed, should walk to the car, open the back of the pick-up and guide (if patient can walk) or carry the patient with the stretcher into the suspected ward. The area where the patient and the Marburg/Ebola ward staff have walked should be disinfected. The burnable waste, reusable protection material and the bucket for vomiting (if used) needs to be taken by the staff dressed in PPE into the Marburg/Ebola ward for burning, proper disinfecting and washing.

**Disinfection of the car**

The back of the pick-up, the mattress, the bucket (if unused), and other items used need to be properly disinfected with a 0.5% chlorine solution. One sprayer can do the spraying on the spot and after disinfection the items can be dried in the sun before reused.

## 4. National health structures

Nosocomial infection in health facilities is common during a FHF outbreak and restriction of risky, invasive procedures should be announced and followed up in the area/district where the outbreak is declared. During a FHF outbreak it is very important to include national health structures, like hospitals, health centers and health posts in the surveillance system for case detection. Normally patients present themselves first at the local health services when they fall sick, as they used to do before the outbreak. Local professionals will need to be trained in case detection to recognize FHF patients and what to do when a case is detected.

### **Free access to health care**

In places where patients have to pay for health care, services in the area/district of the declared outbreak should be made free to increase accessibility for the whole population for the period until the outbreak is declared over. FHF patients might stay at home for financial reasons if health care is not free, leading to amplification of the cases.

This decision should be agreed on during the Crisis Committee meetings and the different partners should discuss who would compensate the health staff and health facilities for the lost income. Donations of material and drugs can be given during an outbreak and at the end of an outbreak.

### **Restriction of at-risk procedures**

The risk for nosocomial transmission can be reduced by training the health staff about FHF and by minimizing risky, invasive procedures in all health facilities, including MSF health settings in the area/district where the outbreak is declared. Therefore only life-saving procedures should be allowed from the beginning until the end of the outbreak, like blood transfusion for severe anemia or operations like Caesarian sections. Vaccinations, injections and laboratory analysis should be suspended in the national health structures during a FHF outbreak to minimize nosocomial infections.

### **Triage**

In hospitals, health centers and health posts a triage system needs to be set up, so that suspect and probable patients are identified and isolated from the others to avoid the spread of the disease, before transport to the Marburg/Ebola unit. Different forms can be used, depending on the amount of patients. All patients should be screened at a triage point by filling in the Triage form (**See Annex 20.1 Triage form** for an example) and active search for patients in the wards should take place. All filled in triage forms should be kept.

National health staff from the hospital or health centers/posts can be trained to do the triage and to temporary isolate an identified suspect case until arrival of the rumor checking team or ambulance team. Small isolation areas can be set up where suspected patients can be isolated while awaiting the ambulance. A medical expatriate is needed for supervising the triage and assessing the identified suspected cases before alerting the ambulance team.

- **Triage in health posts and health centers**

An outreach team needs to pass by all health centers and health posts in the catchments area of the outbreak to provide training and information about FHF infections, and the triage to nurses and nurse assistants.

- **Triage in hospitals**

Every patient that arrives at the hospital needs to pass by a triage point. Different triage strategies can be implemented:

- One triage point can be set up at the entrance of the hospital through which everyone passes. This has been shown to be the easiest manner in terms of human resources and supervision in previous outbreaks<sup>3</sup> OR
  - Different triage points can be set up in different hospital services, to which the patients go directly e.g. one at the OPD and one at the maternity ward. Maternity cases might not pass the OPD and therefore miss the screening.
- **Triage procedures**
- All patients attending health posts or health centers should be screened for FHF by filling in the triage form for FHF and taking the temperature.
  - Each patient should be examined with a new pair of gloves and hands need to be washed with 0.05% chlorine solution after seeing a patient.
  - Suspect cases will need to be separated from the rest of the patients until the ambulance team or the rumor checking team has arrived. Confirmation of the identification of a suspect patient needs to be done by a medical person, e.g. from the rumor checking team, before taking the patient to the Marburg/Ebola ward.
  - The ambulance team needs to be contacted: e.g. via mobile telephone, radio or in person (in which case transport costs should be reimbursed).
  - Staff need to be trained to protect themselves when facing a suspected case: containers for 0.05% and 0.5% chlorine solution should be provided, together with protective clothes. Protective material should be provided according to the level of the staff. However physical contact should be avoided once a case is identified.
  - Disinfection by ambulance sprayer of the area where the patient had been in the health facility.

### **Active search for admitted patients in the ward**

Patients may be missed at the triage points or may develop symptoms after admission that fit the suspected case criteria.

- Temperature should be taken 2-3 times daily from all patients admitted.
  - Patients need to keep the triage form, so checks can be done in a quicker way.
  - A medical person should pass by daily to check all fever cases and all patients identified by the nursing staff as concerning.
  - If a suspect case is identified, the ambulance team should be informed to transport the patient safely to the Marburg/Ebola ward.
  - The ward where the patient was admitted needs to be disinfected by the spraying team.
- See Chapter 7.**

### **Mortality review in the health facilities**

Corpses of patients that died of FHF contain very high levels of the virus and are extremely contagious. The clinical history of all the patients that died in the health settings should be reviewed and suspected bodies should be tested (cardiac puncture, oral swabs, skin snip or liver biopsy) if the laboratory results can be expected within a short time. When taking samples, complete PPE should be used.

If the clinical history is not suspicious for FHF or if the test is negative (with non-suspected clinical history) then the body can be released and the family can do the burial.

However when the clinical history is suspect or the test is positive then the burial team should take care of the disinfection of the body, the ward and the mortuary, and to perform a safe burial. (When a sample is taken, then the body can be disinfected and put in a body bag.)

Contact tracing and follow up needs to be done and health staff that was caring for the patient should be included on the list.

## **5. Protection during activities outside the Marburg/Ebola unit**

How to protect one-self and the disinfection measures used in the Marburg/Ebola ward are clear. However for protection outside the Marburg/Ebola ward, e.g. during contact tracing, rumor checking or triage, improvisation is needed and depends on the situation found.

In previous outbreaks the following practical protection steps were taken, but can't be seen as protection rules that everybody should follow blindly. Every one should protect one self how he/she feels comfortable and according to the situation.

- Always dress up in the green (or blue) suits and put on boots.
- Take gloves, masks, a plastic bag and a hand spray with 0.05% chlorine solution on each outreach activity.
- Always take PPE for minimum 2 people with you.
- Always ask a patient to come out of his hut and start to speak with him at a distance of 2 meters to avoid to get infected by droplets. Ask about symptoms and analyze the situation of the person at a safe distance.
- If a patient complains of a cough, wear a mask (to avoid FHF or TB).
- Always wear gloves and avoid touching a patient when taking the temperature.
- One person should not come in contact with the patient and will carry the hand spray. This person should spray the (non-digital) thermometer after use and the gloved hands of the person examining the person. After each person the pair of gloves should be removed and put in the plastic bag (for burning) and the hands sprayed. A new pair of gloves should be put on for each new person to be examined.
- Community health workers in charge of contact follow up should be provided with gloves, a hand spray and chlorine powder and instructed how to prepare the 0.05% chlorine solution. Instructions about when/how to use and when/how to disinfect the gloves should be given. CHW are not trained to enter the house in PPE and for their safety they should not participate in these activities during the contact tracing and follow up. When a person is too sick to go out of his/hers house, the medical supervisor should be warned or the Rumor Checking Team.
- If a person is too sick to come out of the hut, then complete PPE dressing should be put on. (The hut can be contaminated with body fluids, or it is too dark to ensure safety while entering the hut). Before dressing, the surrounding people will need to be informed why the dressing procedure is needed and how the dressing and undressing will take place. Undressing should always be done in the same manner according to the undressing rules when leaving the hut (in case of suspected or non-suspected ill person) to avoid confusion. Disinfection with 0.5% chlorine solution should take place.
- During triage activities the same principles can be followed, i.e. distance of 2 meter, gloved hands, hand spray, not touching the patient, etc.



## **6. Dressing and undressing during activities outside the Marburg/Ebola unit**

Strong reactions from the community can be expected when seeing the staff dressed up in full protection clothing. Explanation and communication to the community is essential to ensure that activities can be conducted safely.

### **Procedures**

- Dressing and undressing should take place in front of the community/household.
- Put a piece of plastic sheeting on the floor where people will undress.
- When undressing, one person should be disinfected and undress first; then the clean person should use the non-contaminated spraying machine to undress the other sprayer and the contaminated spraying machine. The undressed person should not be too close (2 meter distance and should not stand in the wind to avoid droplets during spraying). If both sprayers are dressed than they can disinfect each other.
- Discard disposable material (gown/overalls, head cover, mask, and surgical gloves) into plastic rubbish bag and close it, spray bag with 0.5% chlorine and put in second bag, close it. Spray again and transport to waste zone at the Marburg/Ebola unit for disposal.
- Spray re-usable items: goggles, household gloves, and apron.
- Place re-usable materials in bucket, spray again, and close lid. Bring to Marburg/Ebola ward to disinfect again.
- Disinfect hands with 0.05% chlorine solution.

### **Key points**

- Early identification and immediate isolation of new FHF cases is essential in outbreak control.
- A surveillance system with contact tracing and follow up, rumor checking and triage in national health structures need to be put in place for detection of suspected cases.
- Patients need to be transported in a safe way to the Marburg/Ebola unit
- Mortality review needs to be done in all health facilities to detect probable FHF deaths, to perform safe burial procedures and to trace and follow up contacts.
- Health care should be free of charge to increase accessibility for patients
- Invasive procedures performed in all health settings, including MSF health facilities in the affected area/district should be restricted to only life-saving procedures to minimize risks for nosocomial infections.
- Protection used outside the Marburg/Ebola unit need to be adapted to the situation
- Dressing and undressing should be done in an open way to the community, following the safety rules.

## Chapter 7. Spraying and safe burial procedures

Home disinfection and safe burial procedures are essential for outbreak control interventions. Correct implementation reduces infection risks for the family members and friends of a patient.

Emotions can be high in the community because normal traditions can't be followed and for people it can be difficult to cope with the strange situation. The security risk may be increased when performing these procedures. Communication and explanations to the community are of great importance to avoid misunderstandings and lack of confidence in the teams and the activities.

---

Teams for disinfecting houses, transferring patients or performing burials, must not arrive on the spot wearing PPE. Arriving in normal clothes helps to normalize the process and the communication with the community. Only after all procedures are well explained, the team members can start to dress up.

---

### 1. Home spraying

The home of a patient that is transported to the Marburg/Ebola unit or of patient that died at home needs to be sprayed. It is unknown how long the FHF virus can stay alive in the body fluid of a patient, therefore all fluids or items touched or used by a FHF patient, should be considered as potentially infectious. For safety reasons and to reassure the family and the community that the home is safe again and items can be reused, the spraying team should disinfect the accommodation where the patient was staying during his/hers sickness and the material he/she had used.

See **Annex 22. Supplies for Spraying Teams** for what to take with you.  
See **Annex 25. Procedures for house disinfection** for more information.

### 2. Spraying of the Marburg/Ebola unit after a discharge, referral or death of a patient

The Marburg/Ebola unit needs to be sprayed after a discharge, a referral of a patient from the suspected area to the confirmed area and after a death.  
After a discharge or referral the mattress, bed and the area around should be sprayed with 0.5% chlorine solution, so that a new patient can reuse the area. See **Chapter 5.10 Discharge procedures – Disinfection**

When a death occurs in the Marburg/Ebola ward, the spraying team/burial team should be informed for disinfection of the body and the area. The dead body needs to be put in a body bag and transported to the mortuary in the isolation area. See **Annex 24. Procedures to clean the Marburg/Ebola unit after a death**. If a death occurs in during the night, these procedures need to be postponed until the next morning to reduce the risk of infection. Spray the patient with 0.5% chlorine, cover with a blanket and leave the screen around the body.

### 3. Safe burial procedures

Performing safe burials disrupts traditional procedures and essential social and cultural rituals. All procedures need to be clearly explained to the family members and community leaders.

A health promoter and/or psychologist can be of great help for communication to the community.

#### **Family involvement**

- The family should be asked to prepare a coffin (if traditionally used) and to prepare a grave at **2 meter deep** at an accessible place. Coffin should be brought to the Marburg/Ebola unit at the exit for the morgue or 2 body bags should be used.
- Family should be encouraged to attend the funeral.
- Family members might help lowering the coffin/body in double body bag and fill the grave with earth after having put examination gloves and latex protection gloves.
- Traditional rituals can be performed if adapted to safe procedures. (E.g. dance and songs should be encouraged to take place during the funeral.
- See **Annex 23. Supplies for Burial teams** and **Annex 26. Guidelines for safe Burial Practices.**

### 4. Community deaths

The message should be passed to the community not to touch and to bury the body of a deceased person and to pass a message to the surveillance team.

A **medical member of the surveillance team** needs to verify all reported recent deaths in the area of the FHF outbreak by taking the clinical history from family members. If there is no suspicion of FHF according to the medical person than the family can perform the burial themselves

If there is a suspicion of a death due to FHF the burial team needs to be informed to perform the safe burial procedures and the house needs to be disinfected. Family should prepare a coffin and a 2 m deep grave as described above.

The burial team needs to dress up in PPE and prepare the body as described in **Annex 26. Guidelines for Safe Burial Practices- 2. Procedure for Burial of suspect/probable/confirmed patient dying at home.** Then the burial team can proceed to the burial procedures.

#### **Key points**

- Home spraying, spraying of the Marburg/Ebola unit and safe burial procedures are essential for outbreak control.
- Community reactions can be very strong while performing spraying and safe burial procedures.
- All deaths in the community need to be checked for suspicion of FHF and for all suspected deaths safe burial procedures need to take place.

## Chapter 8. Logistics

Good logistical support is crucial for the set up and smooth running of the program. Logistic components will be similar for all outbreaks, but actual needs will depend on the size and particularities of the outbreak.

### 1. Emergency preparedness

In countries with a risk of a FHF outbreak, it is advisable to have Module 7 - Sampling & Assessment of the FHF kit ready at capital level. See **Annex 1**.

If a positive case is confirmed and MSF decides to intervene then the complete standard MSF Viral Haemorrhagic Fever (VHF) kit can be ordered. If the standard MSF VHF kit is kept in the field as emergency preparedness, then there is a risk that the items will expire before being used, because human outbreaks of filovirus are sporadic and irregular.

### 2. Security

Community reaction can be very strong in a FHF outbreak. There is potentially a higher than normal security risk when carrying out mobile activities, especially conducting burials, house sprayings or ambulance transport. A close follow-up of the movements of the teams is essential.

### 3. MSF Cars & Communication

Ambulance teams, Burial teams, Spraying teams, Rumor Checking teams, Contact tracing teams and Health Promotion teams all need to move around. For Ambulance and Burial teams cars are essential. The other teams might use different manners of transport (e.g. bikes or by foot), depending on the availability of means and the distances to cover.

Depending on circumstances one vehicle could be used for both burial and ambulance activities. Sometimes the community refuses to enter the car for transportation if the same car is used for burials and it may be necessary to have two vehicles, one being used only for burials, and the other used only for transport of patients. In large outbreaks, more vehicles will be required.

A pick-up car is the most easy to use, because the patient can be transported separate from the staff and the back of the car is easy to disinfect. Hardtops should not be used for the burial or ambulance activities.

Communication is essential for all the teams and reliable communication should be guaranteed at all times. All cars should be preferably equipped with communication equipment.

### 4. Roads

Outbreaks may occur in isolated areas in tropical rain forest regions. Often roads are of poor quality or even non-existent. Adequate time should be planned to assess the accessibility of the roads, improve the quality or even construct new roads to be able to move around in the outbreak region.

## 5. The Base

Requirements for a well functioning base:

- Central location, and easily accessible.
- Secure with sufficient space for computer equipment, communication systems, and coordination meetings.
- Reliable power system.
- Appropriate communication equipment and, if necessary, a radio operator.

## 6. Staff housing

- Accommodation must be of a decent standard. Everybody needs to be able to rest properly, but this is particularly true for people working on high-risk activities, and adequate sleeping facilities must be arranged.
- Where possible, accommodation should be located close to the Marburg/Ebola unit and it should be convenient to allow staff to return for food and rest during the day.
- Bathing and shower facilities must be of a decent standard and have a constant, reliable supply of water.
- In malaria risk areas, it is compulsory to have mosquito nets installed and used, and mosquito repellent must be available for all expatriates.
- Rodents, bats, flies, and mosquitoes must be controlled in the house.
- Domestic hygiene is very important. Cleanliness of the house, and hygiene in food storage, preparation etc. is crucial.

## 7. Marburg/Ebola unit

The logistical needs for the set-up and running of the Marburg/Ebola unit will depend on the situation on the ground; requirements can be defined following the assessment and site planning.

**Table 5. Estimates of Materials for a 10 Bed Unit & Associated Activities**

<b>Disposable Protection Material</b>	<b>Consumption/day</b>
High-risk examination gloves	180 pairs
Household gloves	35 pairs
Surgical gloves	50 pairs
Disposable overalls/gowns	100
Disposable masks	120
Disposable caps (head covers)	120

<b>Diverse Consumables</b>	<b>Consumption/day</b>
Garbage bags	30
Absorbent pads (60x60 cm)	50
Water	3 to 4m <sup>3</sup>
HTH 70%	7kg
Body bags	Quantity will depend on several factors such as virus strain, CFR, etc.

Reusable Material	Requirements / 10days
Scrub suits	90
Boots	45 pairs
Aprons	45
Goggles	120 pairs
Sprayers 12 litres	4
Sprayers 1 litre	10

## 8. Security stocks

A spacious, secure, weatherproof storage is essential for the large volumes of materials that are required. Maintaining adequate security stocks is essential: running out of just one of the protection items e.g. gowns or masks will result in stopping patient care and other activities. Ensure reliable and timely supply of all necessary equipment and materials. While calculating buffer stocks, take into account:

- The contents of the MSF standard VHF kit.
- Most of the protection material is specific and not MSF-standard.
- Non-standard orders can have longer delays than for standard items. Check with Transfer and/or logistic department for advice while establishing buffer stocks.
- The size of the buffer stock will depend on supply lines and availability, both at the local level and internationally. Take account of possible delays at all levels (international, national, customs, transport etc).
- Take account of contingency plans. Ensure there is sufficient material in case the isolation has to be extended, or other sub-outbreaks occur.

## 9. The Kits

### The MSF standard (Filo)Viral Haemorrhagic Fever (VHF) Kit

This kit is designed to allow the set up of a Marburg/Ebola unit of 10 beds and to run it for 10 days. It contains all materials, protective equipment, and drugs necessary to run the unit, as well as associated outbreak control measures, including burial and ambulance teams and medical outreach. Full kits can be ordered at the start of the intervention, but the ordering system should quickly change to order modules separately or item per item orders can be made to avoid over supplies. The Kit consists of 7 modules. For a detailed list of the articles in each module, see Annex 17 Contents of Filovirus Haemorrhagic Fever Kit in the Ebola & Marburg Outbreak Control Guidance.

Module 1 & 1b:	Drugs.
Module 2:	Medical material.
Module 3:	Protection material.
Module 4:	Logistic & Sanitation.
Module 5:	Sampling. (Contains sampling material to take and transport samples, there is no extra material, protective equipment or disinfectants.)
Module 6:	Library, Forms, and Stationery.
Module 7:	Sampling & Assessment. (Contains all necessary sampling material plus protective equipment, disinfection and other materials.)

### **Module 7 - Sampling & Assessment**

It can be useful to have this module on standby in risk countries with many reports of suspected outbreaks, where it can be used for assessment and confirmation of possible outbreaks. This module can be ordered separately.

The module allows a team to safely visit a site; assess a rumor of suspicion of Ebola or Marburg; and safely take, pack and transport samples. It includes all the necessary sampling, protection & disinfection material for two sample takers, and some extra protective material to install a small holding facility.

### **Local Purchase**

The VHF Kit is sent from Europe to set up a Marburg/Ebola Unit and begin work. Further material can be ordered in bulk afterwards. If material is locally available, care is necessary to ensure that the quality meets the required specifications.

### **Solidarity Kit (See Annex 19. Solidarity kit)**

Solidarity kits are provided to discharged patients or to relatives of a deceased patient.

Items can be bought locally and the content of the kit adapted to the cultural habits. Solidarity kits should be ready to be distributed any time.

### **HBSRR Kit (See Annex 15. Caretaker Task Instructions HBSRR and HBSRR Kit)**

HBSRR Kits are used for Home Based Support and Risk Reduction. Some items need to be provided regularly.

### **Key points**

- Good logistical support is crucial for the set up and smooth running of the program.
- Communication means are essential for mobile teams.
- A MSF Standard VHF Kit is available to be ordered and the different modules and items can be ordered separately.

# Chapter 9. Health promotion and psychosocial support

See Chapter Socio-cultural issues and Health promotion and Chapter Psychological and Social support from the Ebola & Marburg Outbreak Control Guidance Manual for more detailed information.

## 1. Health promotion and social, cultural and anthropological issues

In an outbreak situation, analyzing and a good understanding of social, cultural and anthropological issues can play a huge role in the success or failure of the control efforts.

E.g. the effect of health promotion messages and behaviour change efforts depends greatly on the adaptation of the messages to the socio-, cultural and anthropological context.

### Health promotion messages

A two-phase approach for Health promotion messages should be adopted if the context permits it:

#### **Phase A. An initial rapid dissemination of information to the affected communities**

The initial rapid dissemination of information should consist of:

##### **1. Collection of information**

The information collected in the 1<sup>st</sup> phase can be limited to local beliefs and practices related to known risk factors, e.g. activities during burials. Information can be acquired from focus groups and key informants, including health staff, local leaders, religious leaders, traditional healers, birth attendants and patients and patients' families.

##### **2. Check messages given by the MoH and the other actors**

- Are the messages adequate or misleading?
- How and by whom are the messages disseminated?
- Is there a possibility to collaborate?

##### **3. Distribution of information**

It is essential to give the information to the community as quickly as possible. The planning and organisation for the distribution of information and messages concerning the disease and the outbreak control intervention should be started on the very first day of the intervention.

There will be different targets groups e.g. patients and discharged families, the general population, medical staff, the MSF non-medical staff etc. and messages should be adapted to the target groups.

There are 2 types of messages to be given:

- **Operational messages**  
Explanation what MSF is planning to do in to care for patients and to control the outbreak.
- **Disease messages**  
Keep it simple! Messages should include:
  - Confirmation of the existence of the outbreak.
  - Basic information on the disease and transmission methods.
  - Information on how to protect oneself.
  - What to do if someone suspects having acquired the disease.



### **Phase B. In-depth cultural, social and anthropological information and analysis.**

The 2<sup>nd</sup> phase information gathering and messages should focus on issues that were highlighted during the first phase or that have been identified as being particularly delicate or problematic e.g.:

- Beliefs and knowledge about Marburg/Ebola
- Traditional and religious beliefs related to death
- What does a traditional burial look like?
- Beliefs, perceptions and rumours related to MSF and the other actors.
- Beliefs, perceptions and rumours related to the Marburg/Ebola ward.

The regrouping and analysis of this information will permit development of messages adapted to the context.

### **Adaptation of risk behaviours**

One of the roles of health promoters is to try to adapt risk behaviours to reduce the chance of spreading the disease by giving adequate information and messages. Encouraging people to change their behaviour is never easy. However, if the community has confidence in the intervention and its methods, the overwhelming fear of the disease can motivate people to accept the messages and adopt a change in behaviour, at least for the duration of the epidemic.

### **Burials and spraying of patient's houses**

The anthropologist/health promoter may assist when burials or house spraying takes place. Communication and explanation about the procedures to be followed during a burial and spraying is essential to obtain a maximum collaboration with and understanding for the procedures by the family and the community. Traditional rituals during burials can be performed if adapted to safe procedures.

## **2. Psychological and Social support**

This type of outbreak can cause a variety of emotional impacts. Psychological and social support should be provided for patients, their families, the community, and health staff. This support should be offered from the beginning of the intervention. To be relevant, the support and the approach have to be tailored to the social and cultural context.

### **Main Objectives**

- To support affected families by reducing the impact of stress, fear and stigma.
- To facilitate the psychological process for families throughout the various stages: identification, hospitalization, notification of death, burial, and bereavement.
- To improve the quality of care for the patient and family together with other team members.
- To facilitate an understanding of the disease within the community and encourage acceptance of the outbreak control activities.
- To support staff working in the hospital and the Marburg/Ebola unit.

### **Key points**

- Health promotion and psychosocial support are essential in a FHF outbreak and should start at the first day of the intervention
- Activities should be adapted to social and cultural context.

## Chapter 10. Monitoring epidemiological data

To date, knowledge of Ebola and Marburg is quite poor. Good data collection allows the possibility for further analysis and research after the outbreak, which can contribute to improved responses in future outbreaks.

Transferring data out of the Marburg/Ebola ward is difficult, but necessary. All material should be disinfected properly and information written on paper sheets can be problematic to disinfect. Simplest is to dictate the information ‘over the fence’, however this is very time consuming, especially when many patients are admitted. Other options are taking digital pictures on the ‘safe side’ of the fence from papers from the Marburg/Ebola ward. Currently, the ‘best’ method is under discussion and remains unresolved for the moment.

Some of the papers of the medical file can be filled in outside the High-risk area and can stay in the Doctor’s room. (E.g. the Epidemiological form and the Admission form).

### 1. Epidemiological form

For each suspect, probable and confirmed patient (Marburg/Ebola unit and Home Based Care) a standardized epidemiological form (See **Annex 18.2 Admission and epidemiological form** for an example) need to be filled in to uniform documentation of the characteristics of the outbreak.

Data needs to be collected about:

- Clinical presentation: date of onset, symptoms before presentation to the Marburg/Ebola unit, presenting symptoms at admission, etc.
- Contact history with suspected FHF patients: name of contact, type of contact, etc.
- Exposure to possible risk factors: attendance of funeral, treatment received in health posts, etc
- Laboratory investigation: type of sample, outcome, etc.

### 2. Describing the epidemic

Data collection should start with the first identifiable index case: the index case is the first person that could be traced having FHF symptoms and marks the start of the outbreak. Often the ‘real’ index case is difficult to trace, therefore it is better to speak about the ‘first identifiable case’.

Collection and analyzing of data should continue throughout the epidemic. See **Chapter 2.5**

**Describing the situation** for the indicators that need to be collected to describe the epidemic: WIR, AR and CFR and an explanation about the collection of data and organizing data by person, time and place.

General data needs to be collected about the statistics of the Marburg/Ebola unit and the Home Based Care. Information can be given regarding daily, weekly, monthly and total numbers, e.g:

- Number of admissions and discharges
- Total number of patients on the ward
- Deaths
- Recoveries
- Escaped
- Transferred (e.g. from Home Based Care to the Marburg/Ebola unit.)

### 3. Clinical data

The clinical data collected by the medical staff and filled in the Observation sheets, contains important information on:

- The evolution of the disease in the individual cases.
- The provided treatment (supportive and experimental) given and the outcome of the disease.

For further understanding of the disease it is of great value that these data will be gathered and analyzed.

### 4. Epidemiological database

All relevant information should be collected in an epidemiological database to come to a compilation and analysis of all available data about the FHF outbreak. Data base information will be shared at the Task Force meetings. A standardized intersectional Epidemiological Database for Marburg/Ebola outbreaks should be agreed upon by all MSF sections and be available for field use when the next outbreak occurs.

### 5. Epidemiological links and existing transmission chains

Identification of links in between patients is important to understand the modes of transmission, to identify and isolate new patients and to be able to have a close follow up of the persons at risk (the contact persons).

Below is an example from the Marburg outbreak in Uige in 2005, showing the epidemiological links involving four families living very closely together.

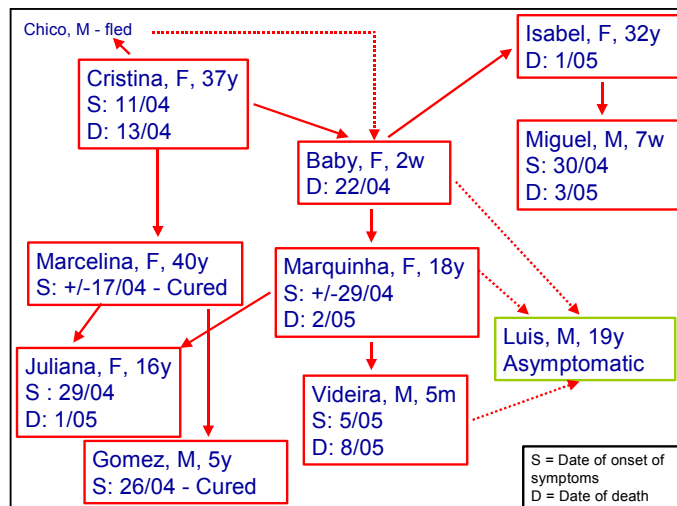

The primary case is Christina, who had severe haemorrhage following delivery. She was admitted to the Marburg ward and tested positive for Marburg. After her death, her husband fled, leaving the newborn baby with the Christina's niece, Marquinha, and with Isabel, both neighbours, who both shared the breastfeeding of the newborn. The baby died 10 days later. Another 10 days later, both Marquinha and Isabel died. Their own babies, who they were also breastfeeding, were infected and died. Marburg virus was isolated from Marquinha's breast milk. It is unclear what the exposure was for Marquinha's husband; as soon as Marquinha fell sick she was left alone with her baby in

a separate house until she died. Another close neighbour, Marcelina, visited Cristina in her home after the delivery. She started symptoms about 1 week later. She lived together with her daughter Juliana, who was a very close friend of Marquinha, helping her out with the care of the children and the household. Juliana died the day before Marquinha. Marcelina has a second child, Gomez, a 5-year old boy who became sick about 10 days after her. Both Marcelina and Gomez were discharged from the isolation - recovered - on the 8th of May.

### **Key points**

- Data collection needs to take place from the earliest identifiable case until declaration of the end of the outbreak
- Data collection and analysis are essential in describing and analyzing FHF outbreaks.
- Clinical data collection and analysis might contribute to a better understanding of the disease and the value of the supportive or experimental treatment provided.
- Compilation of all epidemiological data should be put in a standardized intersectional Epidemiological Database.
- Epidemiological links and transmission chains can be identified by correct data collection

# Chapter 11. Human resources, expatriate life and accidental exposure

## 1. Expatriate staff and expatriate life

A multi-disciplinary team is required to manage correctly a FHF outbreak.

Staff experienced in FHF outbreaks, isolation work and infection control activities should be part of the first team arriving in the field for setting up and initiating of activities.

Inexperienced staff in FHF can be trained and supervised to be able to continue the activities after the experienced team has left.

The quantity of expatriate staff needed depends on what activities MSF subscribes to, the scale of the intervention, the amount of patients and the involvement of other partners in the outbreak.

In general there is a need of:

- |                                       |   |
|---------------------------------------|---|
| - Coordination team:                  | At capital level and at field level   |
| - Medical team:                       | Isolation team, outreach team, medical focal point.   |
| - Water/sanitation team:              | Isolation team, burial/ambulance and spraying team  |
| - Logistics:                          | Logistician for the base, logistician for supply and a logistician for the Marburg/Ebola ward |
| - Epidemiologist:                     | Data collection, data base and analysis   |
| - Psychologists:                      | One for the community and one for expatriate and national staff                               |
| - Sociologist/Medical anthropologist: | Health promotion  |
| - Press-information officer:          | Focus point for communication with media  |

At the beginning of the intervention a lot of activities need to be set up and training to be given.

**It is important to have sufficient experienced staff at the start of the intervention for a short period.** E.g. the water/sanitation team will be busy with organizing the water/sanitation in the Marburg/Ebola unit, burials, ambulance service, spraying of houses and in the meantime staff need to be trained to work in a safe way. Best is to send e.g. 4 experienced water/sanitation people in the beginning and part of them can leave when activities are running in a proper way.

Health promotion and psychological support are very important from the start of the intervention and experts should arrive at the first beginning of the interventions.

### **Before arriving in the field**

A healthy life style is recommended before and during mission (healthy food, enough rest) to optimize physical condition to face the often-difficult circumstances in the field.

All expatriates should receive a briefing at the HQ. The briefing should prepare the expatriate in a realistic way what to expect in the field and should include:

- Medical information on the virus, modes of transmission and symptoms.
- Information about risks related to the job profile.
- Information about protective measures.
- Information about community reactions in a FHF epidemic.
- Psychological briefing: stressors, stress reactions, stress prevention and coping mechanisms.

## Arrival in the field

### ● **Health responsible in the field**

One person in the field is responsible for expatriate and national staff health.

A medical file needs to be made for each expatriate, including: blood group, vaccines, allergies, type of anti-malarial and other medication taken.

### ● **Instructions to prevent diseases**

As FHF have non-specific symptoms and any common disease may be misdiagnosed as FHF with all psychological stress for the ill person and the surrounding persons, measures should be taken to prevent all kind of diseases. All staff will need to be instructed about measures to prevent diseases.

- **No physical contact (physical greetings like kissing or shaking hands, or sexual relations) in the field during the outbreak**  
The risk of transmission of common diseases like respiratory tract infections and gastrointestinal infections and the risk of transmission of FHF within the team will be reduced.
- **Malaria**  
Prophylaxis against malaria is MANDATORY and repellants and impregnated bed nets should be available and used.
- **Gastrointestinal diseases**  
Washing hands, hygienic measures for food preparation, drinking filtered water and regular disinfection of toilet facilities.
- **Urinary tract infection**  
Sufficient hydration is recommendable to prevent urinary tract infections and urinary tract stones, especially in hot climates and for staff working with the PPE (excessive transpiration).
- **General hygiene**  
Hand washing points with a 0.05 chlorine solution at entry of staff compound need to be installed. Sufficient toilets and showers with regular cleaning should be available.
- **Adequate rest**  
The immune system weakens when people get tired.

### ● **Instructions to prevent FHF diseases**

All staff need to be instructed about the measures to be taken to prevent contracting FHF diseases to minimize the risk that a staff gets infected and that FHF infection start to circulate in the team.

- **Isolation staff, outreach + ambulance staff, burial team and spraying team:**  
Use of PPE: teach principles and how to dress and undress.  
Teach about measures to take in case of an accidental exposure.
- **All staff:** As the reservoir is unknown prevention measures need to be taken against bats, rodents and primates:
  - avoid contact with these animals, dead or alive
  - control bats, rats, mice and rodents in the compound
  - don't visit caves (bats are resided in caves)
  - cover food and water
  - rinse dishes, fruit and vegetables before use as they could have been in contact with urine of bats and rats

## During the mission

### • Living conditions

Living conditions need to be optimal according to the circumstances. Stress and tiredness can be better managed when having acceptable sleeping arrangements, privacy possibilities and sufficient and good quality food in a safe place.

### • Rests and length of stay for staff working in outbreak control

Due to the intensity and exceptional circumstances in which the staff is working (vigilance, stress, humidity and heat while working with PPE) regular rests are advisable.

Moreover it is commonly observed that the perception of risk and danger, and the attention to safety precautions applied by the (national and expatriate) staff, is changing in time, and thereby altering the level of risks for the staff. Therefore it is strongly advisable to:

- Take regular breaks during shifts when working in PPE.
- Take at least one day off per week by each team member.
- Replace the set up team after 2-3 weeks and the 'follow up' team every 6-8 weeks.
- Take a short R&R of 3-4 days every 4 weeks for all staff.

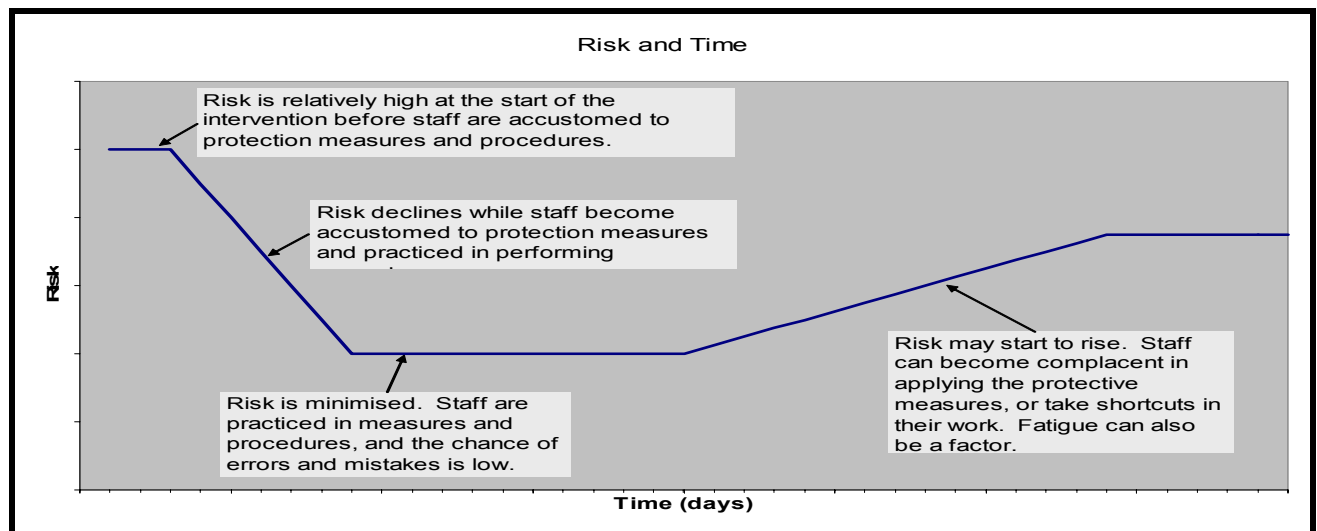

### • Stress during FHF outbreaks

Staff working in a FHF outbreak intervention will be confronted with several stressors and these stressors can lead to different stress manifestations. Some ways to manage stress are mentioned.

#### A. Stressors during FHF outbreaks

- Fear of becoming infected and dying.
- Confrontation with extremely high case fatality rate.
- Limited effect of provided treatment to patients.
- Lack of knowledge of an FHF outbreak.
- Activities often demand 'on the spot' improvisation and adaptation to the circumstances. (E.g. during outreach, funerals or reactions from the community.)
- Personal protection and infection control measures: physical inconvenience of wearing PPE and physical isolation due to prohibition of touching others.

- Effect of outbreak on community: abandoned patients, orphaned children, and destruction of families by amount of family members killed by the virus.
- ‘Normal’ stressors for emergencies: long working hours, working in big teams, separation from personal social network, etc.

### **B. Stress manifestations**

- Not being able to cure patients can lead to feelings of helplessness, guilt and frustration.
- Only having the possibility to provide supportive treatment can lead to feelings of powerlessness.
- Being afraid of getting infected linked with infecting others.
- Psychosomatic manifestations may occur.
- Cumulative and acute stress reactions: sleep disturbances, tiredness, irritability, poor work performance, reduced concentration and memory, etc.

### **C. Ways to manage stress**

- Obtaining knowledge and understanding the risks give a sense of control and ‘all that can be predicted can be better managed’: Participation in briefings and trainings is essential.
- Taking sufficient rest and healthy food for an optimum physical condition.
- Contact with friends and family should be facilitated. (Possibility of regular phone calls and email contact.)
- Individual self-analysis and knowledge about individual signs of stress and coping skills.
- Sharing coping strategies with others: group discussions, individual discussions with other team members and conversations with psychologist (individual and in group).

## **2. Accidental exposure**

Accidental exposures can happen while working in the high-risk area of the Marburg/Ebola ward, during outreach activities, spraying of houses, transporting a patient or during a funeral.

### **Definition of Exposure**

- Needle-stick injury.
- Other puncture, laceration or abrasion caused by potentially contaminated object.
- Unprotected contact with patient’s body or body fluids, or other potentially contaminated material.

**Actions to be taken on the spot:** Do not panic! Try to remain calm and follow the steps below:

#### **A. Needle stick injury, or other puncture, laceration or abrasion injury caused by sharp, potentially contaminated object:**

- Immediately immerse the exposed site in 70% alcohol for 30 sec or 0.5% chlorine solution for 3 minutes.
- Leave the High-risk area with respecting the undressing rules. (A new pair of gloves may need to be put on before undressing in case exposure took place at the gloved hands. Otherwise after disinfection the wound may come in contact with contaminated PPE when undressing!)
- Thoroughly wash affected area with soap and clean water.
- Flush with clean running water for 30 seconds.
- Apply dressing if required outside the High-risk area.



**B. Unprotected contact with FHF patient’s body or body fluids, or other contaminated Material:**

- Contact with the eyes:
  - Immediately flush the affected eye with copious amounts of non-chlorinated clean water, ringer lactate or sodium fluid.
- Contact with the mouth or nose:
  - Immediately rinse the mouth or nose with 0.05% chlorine solution. Do not swallow the chlorine solution.
  - Rinse mouth or nose thoroughly with clean water
- Contact with broken skin:
  - Rinse the affected area with 0.5% chlorine solution.
  - Thoroughly wash the affected area with soap and clean water

**Degrees of risk**

There are different degrees of risk with different actions to be taken.

**Table 6. Degrees of risk for accidental exposures**

Degree of risk	Description	Example	Action
<b>Very high</b>	Puncture injuries with infected instrument	Needle-stick injuries.	Evacuation out of country.
<b>High</b>	Any contact of eyes, mucus membranes, or broken skin with infectious material (which are those containing or contaminated by body fluids or wastes from a symptomatic FHF patient)	FHF patient coughs directly into unprotected eyes.  Hand contaminated by vomit from FHF patient touches mouth, etc.	Evacuation out of country.
<b>Unclear/ Variable</b>	Direct contact between intact skins.  Contacts intact skin with infectious material  Contacts mucosa with disinfected material	Touched by symptomatic FHF patient.  Saliva, soiled clothes on bare skin but not mucus membranes  Splash of chlorinated solution containing infectious waste into eyes	Observation at field or capital level.
<b>Nil</b>	Contact between well disinfected material and intact skin	In chlorine solution washed clothes on bare skin.	None.

Accidental exposures need to be reported to the medical responsible and the coordinator.

- Action needs to be taken according to the degree of risk of contamination.  
See **table 8. Degrees of risk for accidental exposures.**
- The exposed person becomes a contact and must be followed for 21 days.
- HIV Post Exposure Prophylaxis (PEP) needs to be provided if advised and Hepatitis B vaccination if not up to date.
- Cause of accident needs to be analyzed and corrective action taken to prevent future accidents.

## **Evacuation**

A medical evacuation during a FHF outbreak differs greatly from medical evacuations in other situations. Countries may refuse to accept evacuated expatriates and pilots may refuse to fly them. Moreover using a commercial aircraft can provoke damaging negative publicity for MSF when it becomes known that MSF allowed a person exposed to FHF to use a commercial flight. Therefore, MSF can't give a 100% guarantee that evacuation will be possible.

Before a FHF outbreak intervention starts, the MSF section involved in the intervention, needs to:

- Verify the agreements with insurance companies (SOS) for FHF evacuations.
- Identify Biosafety p4 level laboratory for diagnosis.
- Identify a high standard hospital with Intensive Care facilities and isolation possibility and willing to accept and capable to care for an evacuated expatriate. High standard health care can optimize the chances of survival and the convenience of the patient during the disease.

Depending on the situation, a person can be evacuated to:

- The capital of the affected country.
- A neighboring country.
- The country of MSF operational centre.
- The person's home country.

There are 3 scenarios for evacuation:

### **Scenario 1: Working accident: Puncture incidents or contact with any body fluid in eyes, mucus membranes or broken skin.**

- Person is considered a contact and should be followed during 21 days.
- An asymptomatic person is no risk to others
- The window between exposure and development of symptoms (and beginning of period of infectivity) is at least 48 hrs.
- Evacuation to a country with high standard hospital facilities where the person can be admitted in case of developing symptoms. In some cases the receiving country might decide that the person should be isolated preventively during the incubation period.

### **Scenario 2: Fever**

- Exclude for other causes of fever (paracheck, etc.)
- All patients with fever should be evacuated to the capital and will be placed in a MSF isolation guesthouse. Laboratory results can be awaited here. Protective gear and isolation measures need to be available at all times.
- The decision for immediate evacuation out of the country should be based on degree of exposure and probability of infection.

### **Scenario 3: Unexplained hemorrhagic symptoms or severe disease with fever: Probable case in latest phase**

- Level of contamination is high.
- Isolate immediately, give appropriate care and send blood sample.
- Evacuate if possible to a place where all isolation precautions are in place.
- Infection control measures: disinfection of residence and car/plane if used for transport.
- Psychological support needs to be given to the patient, the team and the family.

### **3. After the mission**

Besides a normal debriefing, expatriates returning from mission should be offered psychological debriefing at HQ and psychological support should be facilitated for those in need. Stigmatization of staff returning from mission can be a problem.

#### **Normal life**

It should be well explained to colleagues, family and friends that there is no risk in having contact with expatriates returning from a FHF outbreak. An expatriate can live a normal life without taking any precautions if he is not suffering from any symptoms and without a history of accidental exposure.

Only restriction is that during the 3 weeks of incubation period after returning from the FHF affected area, it is recommended that all expatriates stay within reach of a good quality health facility in case the expatriate develops symptoms that turn out to be FHF.

For staff leaving at the end of the outbreak, the 21 days will be counted from the day of last contact with a suspected, probable or confirmed patient.

#### **Falling sick in incubation period after returning from the field**

In case an expatriate falls sick (fever or other symptoms) during the incubation period, he should be considered as a suspect case until the contrary is proven.

The following actions should be taken:

- Contact should be made with the medical referent from the HQ. Each section has one medical referent on call. If the medical referent decides that the expatriate is suspected for FHF infection, then the medical referent contacts the reference hospital identified with testing possibilities for FHF, appropriate isolation facilities with Intensive Care possibilities and capable and willing to accept the sick expatriate.
- Transport to the hospital must be in a way that minimum contact takes place with unprotected individuals, by driving him/her self or via a specially prepared ambulance.
- If the expatriate has turned out positive for FHF, the residence should be decontaminated as soon as possible and contact persons should be followed.
- Psychological support needs to be given to the expatriate and the family and friends.

### **4. National staff**

#### **Recruitment**

Recruitment of national staff can be problematic due to the fear and the stigmatization of the disease. Often members of the national health staff have become infected and died in the time that it was still unknown that a FHF outbreak had started and no protection was taken. Colleagues have been nursing them and often seen their colleagues dying.

Sometimes staff needs to be recruited from other regions in the country. If a FHF outbreak has occurred in previous years in the country, then this experienced staff can be hired. Staff need to be well-paid for their work.

#### **Training, safety, supervision and psychological support**

Safety of staff is a top priority. Therefore briefing and general training about the disease and specific training about the safety procedures needs to be given and repeated regularly. Supervision should be given continuous. Adequate support and protection of the health personnel will increase their

confidence and motivation to continue to work in the extreme conditions of an outbreak of haemorrhagic fever. A risk allowance will be provided for all the staff working in the high-risk area. Measures to take to prevent diseases and FHF are the same for national staff as for expatriate staff. Regular psychological support needs to be offered to the national staff.

### **Evacuation**

If a national staff falls sick or has a working accident, evacuation should take place to the capital where the staff member will stay in a MSF isolation guesthouse for care or for observation. A caregiver of the individual should be identified and all costs and protection measures should be assumed by MSF.

### **Key points**

- All staff need to follow instructions about measures to prevent diseases and FHF infection.
- Staff is exposed at high levels of stress: proper rest, a healthy life style and psychological support are advised.
- Depending on the degree of risk after accidental exposure, a team member might have to be evacuated.
- After the mission the expatriate can lead a normal life if he/she didn't have a history of accidental exposure and is not suffering of any symptoms.

## Chapter 12. The end of the epidemic

### 1. When to declare the end of the outbreak

The official end of the outbreak will be declared 42 days, i.e. 2 times the incubation period, after the day of admission of the last laboratory confirmed FHF patient in the Isolation facilities and/or the HBSRR.

General restrictions and restrictions in health services during the FHF outbreak will be lifted: e.g. surgery activities, vaccination and laboratory tests will be possible again like before the outbreak. An information campaign to inform the community can facilitate the restart of these activities.

### 2. End of MSF intervention

Epidemiological data will assist in determining when to reduce the activities in the Marburg/Ebola unit. Staffing and activities can be scaled down when numbers of new cases are consistently reducing and the outbreak is under control. If no new cases have been reported for 21 days, the outbreak can be considered to be over, assuming that contact tracing and case finding activities are reliable and efficient.

After the 21 days, the Marburg/Ebola ward activities can be put on stand by, meanwhile surveillance, health promotion activities and psychosocial support will continue. A handover can be given to the MoH to continue these activities. If local capacities are considered to be adequate, the handover can be given at an earlier stage.

### 3. Closing down the Marburg/Ebola unit

After the declaration of the end of the outbreak, the buildings and facilities should be returned for use to the local medical authorities. All potentially contaminated material in the compound, buildings and facilities must be disinfected, destroyed, and/or made inaccessible (by burning and burying). See **Annex 27. Treatment of facilities and equipment when closing the Marburg/Ebola unit.** During the closing down period Task Force meetings should continue to take place to coordinate the still ongoing intervention activities and the scaling-down procedures.

### 4. FHF preparedness for future outbreaks

In countries where FHF outbreaks have occurred in the past (Sudan, Gabon, Uganda, DRC, Republic of the Congo, Ivory Coast and Angola) it is advisable to:

- Have a FHF assessment kit ready at capital level (check expiry date)
- Agree on a single, standard case definition with partner organizations.
- Set up a surveillance system in hospitals and health centers in the country, with an early warning possibility (phone/radio) for a FHF alert. See **Chapter 2.1 Triggering the alert.**
- An assessment should be carried out when an alert is triggered.

### **Key points**

- Official declaration of the end of a FHF outbreak is 42 days after the last admission of a FVF confirmed case.
- Structures and material need to be disinfected or destroyed.
- Marburg/Ebola unit activities can be stopped when there are no new cases for 21 days.
- FHF preparedness at capital level and set up of a surveillance system in Ministry of Health structures in countries with a history of an outbreak is recommendable

## Annex 1. Module 7 – Sampling & Assessment

	KMEDZTF0072	MODULE 7 - SAMPLING & ASSESSMENT			
1	EMEQTOUR1--	GARROT elastique, 100 x 1,8 cm; TOURNIQUET, rubber band, 100 x 1.8 cm	1		
2		BOITES A RECUPERATION AIGUILLES 4L (plastique); SHARP CONTAINER, 4L (plastic)	2	MERCK Eurolab ® HUAR 200 4L;	Must be disposed of safely.
3	DEXTIODPIS2	IODE POVIDONE, 10%, solution, 200 ml, fl. Verseur ; IODINE POVIDONE, 10%, solution, 200 ml, dropper bot.	1		Antiseptic and disinfectant (medical use).
4	SDRETAPA025	SPARADRAP, oxyde de zinc, ROULEAU, 2 cm x 5 m; TAPE, ADHESIVE, zinc oxide, ROLL, 2 cm x 5 m	1		
5	EMEQSPHY1A-	SPHYGMOMANOMETRE, manopoire, velcro, adulte ; SPHYGMOMANOMETER, hand manometer, velcro, adult	3		Disinfect properly between (suspect) cases.
6	EMEQSPHY1P-	SPHYGMOMANOMETRE, manopoire, velcro, enfant; SPHYGMOMANOMETER, hand manometer, velcro, paediatric	3		Disinfect properly between (suspect) cases.
7	EMEQSTET2--	STETHOSCOPE, double face, clinicien; STETHOSCOPE, double cup, clinician	3		Disinfect properly between (suspect) cases.
8	SMSUTHER1R-	THERMOMETRE, rectal, Celsius, + etui de protection ; THERMOMETER, rectal, Celsius, + protecting cover	5		Use as AXILLARY thermometer ONLY.
9	SDRECOTW5R-	COTON hydrophile, ROULEAU, 500 g ; COTTON WOOL, hydrophilic, ROLL, 500 g	1		
10		GANTS DE MENAGE, caoutchouc, reutilisable (la paire) ; GLOVES, CLEANING, rubber, reusable, (pair)	3	HOSPITERA "GREENFIT PLUS"	Use as second pair for specific heavy duty jobs.
11		GANTS D'EXAMEN HAUT RISQUE, usage unique, ; HIGH RISK EXAMINATION GLOVES, disposable,	300	Nitra Tex EP Ansell Medical ® 100 pce Small; 100 pce Medium; 100 pce Large)	Basic (first) pair of gloves.
12	SMSGLOS8--	GANTS CHIRURGICAUX, Latex uu paire; GLOVES SURGICAL disposable Pair	50		Use as second pair for sensitive jobs (e.g. pulse taking).
13	ELINTROS1W-	PANTALON CHIRURGICAL, tissé TROUSERS, SURGICAL, woven	100		1 per shift for each isolation worker, and members of the ambulance & burial teams. (= trousers of scrub suit)
14	ELINTUNS1W-	TUNIQUE CHIRURGICALE, tissée TUNIC, SURGICAL, woven	100		1 per shift for each isolation worker, and members of the ambulance & burial teams. (= blouse of scrub suit)
15		CASAQUE CHIRURGICALE.uu., avec manches longues; DISPOSABLE GOWN with long sleeves	28	HARTMANN ® XXL.	
16		SALOPETTE de PROTECTION; PROTECTIVE OVERALL	10	Mao collar welded overall. Topguard ®; Tyvek-Pro.Tech ® -- NON STERILE	
17	SDREBANC103	BANDAGE, COHESIVE, elastic, 10 cm x 3 m BANDE COHESIVE, élastique, 10 cm x 3 m	2		For securing fitting of wrist band of gown with edge of glove.
18	ELINAPRS1R-	TABLIER PROTECTION, plastique HEAVY DUTY; APRON PROTECTION, plastic HEAVY DUTY	5	APRON SURGICAL, rubber	
19		BOTTES, caoutchouc, (pair) <b>BLANC</b> ; BOOTS, rubber, (pair) <b>WHITE</b>	5	2 pairs size 39; and 3 pairs size 43	
20	ELINMASPIHF	MASQUE DE PROTEC., RESP.(PCM2000 FLUIDSHIELD) haute filtra; MASK, PROTECTION, RESP.(PCM2000 FLUIDSHIELD) high filtration	100		

21		COIFFE CHIRURGICAL u.u. ; SURGICAL CAPS Disposable	50	Cagoule Ortopédique non tissé polypropylène souple et léger EVERCAP ® REF C12 ; Code 686408BD (Hospitera)	
22		COIFFE avec masque a six lacets incorporés; CAP (HOOD) with 6 laces mask	50	Topguard ®; Tyvek-Pro.Tech ® -- NON STERILE	
23		LUNETTES DE PROTECTION, plastique (GOGGLES), ; GOGGLES, PROTECTIVE, plastic	5	FLEXY® wraparound Goggles BS 2092,2 CDM	Use anti-fog spray provided in same module of kit.
24		SPRAY anti-Buée;(2 ounce spray); Anti-FOG spray (2 ounce spray)	1	= diving spray (Trident, 2 ounce spray, #LP80)	Use to diminish fogging of goggles.
25	SMSUBAGB2W-	SAC, plastique, mortuaire, blanc, 150 microns, 220 cm ; BAG, body, plastic, white, 150 microns, 220 cm	4		Use double if no coffin.
26		EBOLA BRIEFING MSF 2001	1		Briefing document & field use.
27	L002CLIG01E	CLINICAL GUIDELINES	1		MSF standard clinical guideline (English)
28	L002CLIG01F	GUIDE CLINIQUE ET THERAPEUTIQUE	1		MSF standard clinical guideline (French)
29	L014DRUG01F	MEDICAMENTS ESSENTIELS - Guide pratique d'utilisation	1		MSF standard essential drugs guideline (French)
30	L014DRUG01E	ESSENTIAL DRUGS - Practical guidelines	1		MSF standard essential drugs guideline (English)
31	L003HEFB02F	Controle de l'infection en cas de FIEVRE HEMORRAGIQUE VIRALE en milieu hospitalier africain, OMS/CDC 208 p	1		Guidelines for Viral Haemorrhagic Fevers (French)
32	L003HEFB02E	Infection control of VIRAL HAEMORRAGIC FEVERS in Afr. health. WHO/CDC 198p	1		Guidelines for Viral Haemorrhagic Fevers (English)
33	L003ZTF0002	PROCEDURE DE PRELEVEMENT DE SANG FR;	1		MSF - Guidelines for sampling taking (French).
34	L003ZTF0002	PROCEDURES FOR BLOOD DRAWNING ENG.	1		MSF - Guidelines for sampling taking (English).
35	L003ZTF004	Standard Forms for Haemorrhagic Fev. (paper) Eng + fr.Set	2		Case and contact definitions (EHF); Case reporting form; Contact recording form; Contact tracing form; Steps for putting ON (& OFF) protective clothing); Clinical data form.
36	L003ZTF004	Standard Forms for Haemorrhagic Fev. (disc) Eng + fr.	1		Case and contact definitions (EHF); Case reporting form; Contact recording form; Contact tracing form; Steps for putting ON (& OFF) protective clothing); Clinical data form.
37	ASTABOOE2SH	CAHIER, 210 x 297 mm, à spirale, quadr. 5 mm, rigide, 180p.; EXER. BOOK, 210x297mm, spiral bind, 5mm sq, hard cover, 180p	1		
38	ASTAPENM3BB	MARQUEUR, noir, indélébile, géant, pointe carrée ; MARKER, black, permanent, large, square tip	1		
39	ASTAPENF1BS	CRAYON FEUTRE, pointe fine, noir; PEN, FELT, black, sharp	3		
40	PPACBAGP1B-	SAC, poubelle, plastique, 100 l, noir, 70 microns ; BAG, dustbin, plastic, 100 l, black, 70 microns	20		
41		PULVERISATEUR 1L Plastique SPRAYER 1L Plastic	3		
42	CWATZTF0104	CUILLER A SOUPE, plastique, 15 grammes; PLASTIC TABLE SPOONS 15 gr plastic	5		For measuring chlorine (1 table spoon (cuiller à soupe) holds ~15 g HTH).
43	CWATYCAH7G5	HYPOCHLORITE de CALCIUM (HTH) 70% granules 500 g embal. IATA; HTH 70% IATA PACKING	5	IATA Packing	Disinfection; Water treatment.
44	DEXTSOAP1B2	SAVON, 200 g, barre; SOAP, 200 g, bar	10		
45	PPACTAPE1M-	RUBAN ADHESIF, MSF, PVC (rouleau); TAPE, adhesive, MSF, PVC (roll)	1		



46	ESURSCIS24-	SCISEAUX DE LORENZ, courbes, 24 cm 40-13-24 SCISSORS, LORENZ, curved, 24 cm 40-13-24	1	LORENZ Ciseaux à pansements, Courbés, 24 cm de long, <b>MEDICOM INSTRUMENTE® ref. 40.13.24</b>	
47	CSHETAPE2BF	RUBAN DE BALISAGE, blanc/orange, fluorescent, rouleau 500 m ; TAPE, BOUNDARY marking, white/orange, fluorescent, roll 500m	1		Quick pre-fencing of risk zones or isolation unit.
48	KMEDMSAMIS-	MODULE PRELEVEMENT SEROLOGIE, transport ; MODULE, SAMPLE, SEROLOGY, transport	2		For sampling on filter paper.
49	ELAEBSVCI1P-	(système prél.sanguin) RECIPIENT PROTECTEUR ; (blood sampling system) CONTAINER, PROTECTION	10		For blood sampling.
50	ELAEBSVV1H-	(s.prél.sang.) CORPS PORTE TUBE (Vacutainer) ; (blds. syst.) HOLDER for VACUUM TUBE (Vacutainer)	15		For blood sampling.
51	ELAEBSVV21N	(s.prél.sang) AIGUILLE, stérile, 21G (Vacutainer); (blds.syst.) NEEDLE, sterile, 21G (Vacutainer)	10		For blood sampling.
52		SKIN-SNIP-BIOPSY-SET (MSF packed) composed of : (1 x POINCON A BIOPSIE USAGE 5mm UNIQUE--SKIN BIOPSY PUNCH 5mm disposable); (1 x SET ENLEVEMENT DE FIL UU; -- SUTURE REMOVAL KIT DISPOSABLE); (2 x RECIPIENT avec FORMOL (min 20 ml); -- VIAL WITH FORMALIN (min 20 ml))	3	Each set needs to be packed separately.	For skin-snip biopsy.
53		(Liver puncture) Aiguille pour biopsie de tissu (Liver puncture Needle for tissue biopsy)	1	Monoject biopsy needle 13G, 3 1/2" Kendall ® code 1100-247194	For liver biopsy (post-mortem) If required to take liver sample, only physicians experienced in biopsies should do this.
54		(Liver puncture) RECIPIENT avec FORMOL (min 20 ml); (Liver puncture) VIAL WITH FORMALIN (min 20 ml).	2		For liver biopsy (post-mortem) If required to take liver sample, only physicians experienced in biopsies should do this.
55	SINSSYRD10-	SERINGUE, u.u., Luer, 10 ml SYRINGE, disposable, Luer, 10 ml;	5		
56	ELAECONT6U-	POT A PRELEVEMENT, urine, plastique, non stérile, 60 ml CONTAINER, SAMPLE, urine, plastic, non-sterile, 60 ml;	5		For urine and stool samples. Respect cold chain for differential diagnosis (dysentery).
57		BOITE, emballage triple, transport Diagnostic Specimen; BOX, triple packing, transp. of Diagnostic Specimen.	2		For transport of samples of unknown diagnostic.
58		BOITE ISOTHERM, emb. Triple, transp. Diagnostic Specimen; BOX ISOTHERM, triple pack., transp. of Diagnostic Specimen	2		For transport of samples of unknown diagnostic.
59	ASTASTIC428	ETIQUETTE, AUTOCOLLANTE, A4, 28 unités 105x25 mm, pr fiches ; STICKER, ADHESIVE, A4, 28 units 105x21 mm, for stock card	100		For identification of samples.

## Annex 2. Authorized Filovirus Testing Centers and WHO contact information

Filovirus testing centre	Address	Telephone/Fax number	Email
Centre for Disease Control and Prevention (CDC)	National Center for Infectious Diseases, Division of Viral and Rickettsial Diseases, Special Pathogens Branch, 1600 Clifton Road, MS G-14 Atlanta Georgia 30329-4018, USA	Tel. 001-404-639-1115 Fax. 001-404-639-1118	CJPO@CDC.GOV
National Institute for Virology	Special Pathogens Unit Privat bag X4 Sandringham 2131 Zaloska 4, South Africa	Tel. 0027-11-882-9910 or 0027-11-321-4200 Fax. 0027-11-882-0596 or 0027-11-882-0596	
US Army Medical Research Institute of Infectious Diseases (USAMRIID)	Fort Detrick Maryland 21 702-5011 USA	Tel. 0014046391115 Fax. 0014046391118	
Division of Pathology Centre for Applied Microbiology and Research	Porton Down Salisbury Wiltshire SP4 OJG UK	Tel. 00441980612224 Fax. 00441980612731	
Institut Pasteur, Lyon	Unit of viral hemorrhagic fevers 21, Av. Tony-Garnier 69 365 Lyon cedex France	Phone secretariat: +33437282421  Contacts: Dr. Herve Zeller: +33437282457 Dr. Marie Claude Geoges: +33676933119 Dr. Vincent Debel: +33688389567	Zeller@ cervi-lyon.inserm.fr

Agency	Address	Telephone/fax number	Email
World Health Organization	Communicable Disease Surveillance and Response (CSR) WHO 20, Avenue Appia CH-1211 Geneva 27 Switzerland	Tel. +41227912909 Fax. +41227914198	<a href="mailto:csr@who.int">csr@who.int</a> or <a href="mailto:outbreak@who.int">outbreak@who.int</a>  Global Outbreak Alert and Response Network (GOARN) <a href="mailto:goarn@who.int">goarn@who.int</a>
	Centre International de Recherches Médicales de Franceville (CIRMF) Boite Postale 769 Franceville, Gabon	Tel. +241 677092/96	<a href="mailto:faxcirmf@yahoo.com">faxcirmf@yahoo.com</a>

### Annex 3.A Case definitions and their use

Case definition	Applied by	Use	Action if fitting in case definition	Remarks
<b>Alert Case</b>	Community members.	To decide if person needs to be further evaluated by health professional	Call mobile team lead by a health professional.	
<b>Suspect Case</b>	Health professional (nurse, clinical officer or medical doctor for outreach).	To decide if ill person needs to be taken to the Marburg/Ebola ward.	Safe transport to Marburg/Ebola ward.	
	Medical doctor in charge of Marburg/Ebola ward.	To decide if ill person needs to be isolated in the Marburg/Ebola ward.	Isolation of patient in suspected area. Start contact tracing and follow up of contacts*	Taking into account case definition, clinical skills and experience the medical doctor in charge decides after assessment if the suspect case is a real suspect and needs to be isolated or that the case is not suspected and the patient will be treated for or referred for further treatment of other diseases.
<b>Probable Case</b>	Medical doctor in charge of Marburg/Ebola ward.	To decide if ill person needs to be isolated separately from the other suspected cases, while waiting for the laboratory results.	Move patient to the probable area in the Marburg/Ebola ward. Start contact tracing and follow up of contacts*	Some patients might have clear (haemorrhagic) symptoms highly suspected to be caused by FHF. While waiting for the laboratory results (which, at times, can take days) it can be decided that these patients will be separated from the other patients by admitting them temporary in a probable area until lab results are known. This area can be completely separated from the suspected or confirmed area, or a separation can be made in the suspected or confirmed area. The location of the probable area in relation to the suspected and confirmed area will vary depending upon the set-up of the isolation area, the caseload, space and available human resources. The doctor in charge should have the final decision on where the probable cases should be isolated.
<b>Confirmed Case (Lab test positive)</b>	Medical doctor in charge of Marburg/Ebola ward	To decide that patient has the disease, confirmed by laboratory test.	Move patient to confirmed area in Marburg/Ebola ward and continue contact tracing and follow up*	

\* Depending on the time it takes to obtain the laboratory results, contact tracing and follow up should start immediately.

Contact tracing and follow up of contact persons of the suspect case can be stopped when the laboratory test turns out negative,

but the negative suspect case needs to be followed up during 21 days after discharge as he/she is seen as a contact after his stay in the suspected area of the Marburg/Ebola ward

## **Annex 3.B Suggested case definitions**

### **Alert case:**

Any person with (or history of):

- Sudden onset of fever **OR...**
- Unexplained bleeding symptoms **OR...**
- Unexplained death

### **Suspect case:**

Any person with (or history of):

- Fever\* + Contact \*\* **OR...**
- Fever + 3 or more of the following general symptoms:
  - Headache
  - Vomiting
  - Diarrhea
  - Anorexia
  - Nausea
  - Weakness or severe tiredness
  - Myalgia
  - Dysphagia
  - Arthralgia
  - Hiccup
  - Dyspnoea
  - Abdominal pains **OR...**
- Fever + Unexplained haemorrhagic symptoms, spontaneous abortion or miscarriage
- Contact + 3 or more general symptoms **OR...**
- Contact + Unexplained haemorrhagic symptoms, spontaneous abortion or miscarriage **OR...**
- 3 or more general symptoms + Unexplained haemorrhagic symptoms, spontaneous abortion or miscarriage **OR...**
- Death with a clinically suspected history \*\*\*

### **Probable case:**

- Suspect case assessed by medical doctor and classified as probable case based on case definition, clinical symptoms and doctors' experience.
- Deceased individual with epidemiological link \*\*\*\* (Used retrospectively by epidemiologists.)

### **Confirmed case:**

- Any person with any positive laboratory result:
  - PCR (oral swab or blood)
  - Serological test

- Antigen
- \* Definition of fever:  
An axillary temperature of 37.5° C or above is defined as fever. Fever can be absent in late stages of the disease, but then the patient most likely has many other symptoms.
- \*\* Definition of a contact:  
A **contact** is any person who has come into contact with a suspected, probable or confirmed case in the last 21 days (incubation period). Apart from 'No contact', contacts are categorized into 2 groups according to type and intensity (i.e. inherent possibility of getting infected):
  1. Indirect contact:
    - Sleeping in the same household as a potentially-infected FHF patient or touching objects used by the individual (e.g. cutlery or clothes) in the last 21 days **OR...**
    - Having being admitted in the suspected area in the Marburg/Ebola ward but turned out to be a negative case. (Although all measures are taken to prevent contact between suspected and confirmed area, theoretically there is a chance of becoming infected.)
  2. Direct contact (stronger contact = increased chance of becoming infected):
    - Contact with the body or body fluids (including breast milk) of a potentially-infected FHF individual in the last 21 days (including relatives involved in care in the Marburg/Ebola ward) **OR...**
    - Contact during funeral practices in the last 21 days, included:
      - direct contact with the corpse of a potentially infected FHF individual
      - the corpse's body fluids
      - potentially-contaminated objects such as soiled clothes or mattresses utilized during funeral preparations.
- \*\*\* Safe burial practices need to be performed if not yet buried or burned by the family.
- \*\*\*\* Definition of an epidemiological link:
  - Direct contact history with suspect, probable or confirmed case in the last 21 days **OR...**
  - Contact with sick or dead non-human primate (gorillas, chimpanzees or monkeys) in the last 21 days **OR...**
  - Received treatment (transfusions, injections, etc.) in the last 21 days at a health structure that was linked to known cases (suspect, probable or confirmed case)

**Remark:**

Case definitions need to be agreed upon by all partners involved in an outbreak. These suggested case definitions are written based on the scientific data known at the moment of writing. (E.g. for the epidemiological link: it is known that gorillas infected with Ebola or Marburg can infect humans). Future case definitions will be adapted, as more information about the reservoir and/or other possible modes of transmission to the human population is known.

#### Annex 4. Sample information and conservation per transport medium

At what temperature the transport medium can be transported and how long after sampling taking the laboratory test can be done, depends on the transport medium.

Disease	Transport medium		Taken from	Testing	Conservation temperature		Conservation time after sampling
					Before use	After use	
FHF	Whole blood	Filter paper	Living suspect case	ELISA	RT*	RT	Up to 3 wks
		Dry tube	Living suspect case or until 1-2 days after death	PCR, ELISA, antigen	RT	2°- 8° C	72 hr up to 1 wk
	Oral swab		Living/ dead suspect case	PCR	RT	2°- 8° C	72 hr up to 1 wk
	Skin snip in formalin		Dead suspect case	Antigen	RT	?	?
	Liver biopsy in formalin		Dead suspect case	Antigen	RT	?	?

\*RT = Room Temperature

## **Annex 5. Laboratory tests**

Accuracy and use of the different laboratory tests may change over time. At the beginning of each outbreak, advice should be obtained from the laboratory center that will be involved in the outbreak.

### **1. PCR Test**

The Polymerase Chain Reaction Test is the test mostly used for confirmation of diagnosis in the field. It can detect strands of the viral RNA in:

- Blood sample (whole blood in tubes or on filter paper)
- Oral swab

The PCR is considered to be very specific. Any positive test (blood or oral swab) confirms the disease. The transport medium should be discussed with laboratory receiving the sample.

A negative PCR test in a recovering patient shows that the level of virus have dropped to undetectable levels, implying that there is less risk of the individual spreading the disease. This result can therefore be used to help in difficult discharge decisions.

---

Only the blood test is used to rule out the disease. The oral swab test is thought to be less sensitive and therefore a negative test does not rule out the disease.

---

There are 2 limitations of the PCR test:

- False negative results can occur in the first 3 days of symptoms when the viral load is low. If the disease is suspected and the result is negative, the test needs to be repeated on or after the 4<sup>th</sup> day of symptoms.
- Reverse transcriptase inhibitors might be present, resulting in a false negative test (throughout the disease period). Discuss with the laboratory if the patient is clinically highly suspected to have FHF infection and the tests results are negative.

Whole blood can be collected:

- In blood tubes (samples need to be collected in 2 tubes):
  - o An EDTA tube (anti-coagulation tube with purple cover)
  - o A dry tube (without anti-coagulation and with red cover)
- On a filter paper.

The use of the filter paper has some restrictions for the diagnosis:

  - o Isolating the virus and identification of the genotype is impossible.
  - o PCR on filter paper is less sensitive and often 2-3 samples are needed to be able to detect the strands of the virus.

Oral swabs are collected by:

- Rubbing a swab along the area where the teeth meet the gums.
- This should be done along the line of the front teeth of both jaws. It is best done firmly to enable cells to be collected.
- This test is more sensitive when done on severe cases or dead patients.

## **2. Antibody detection with ELISA**

ELISA tests detect the appearance of antibodies IgM and IgG.

IgM antibodies appear early in the disease (between day 2-9 of clinical illness, usually gone after 6 weeks from initial infection) and shows a recent infection. However, due to the immune suppression, the response to the virus is variable and the sensitivity of the IgM test is thought to be lower than that of the PCR.

IgG antibodies appear late in the disease (between day 6-18 days after onset of the disease, may last 2 years or more), often as a sign of recovery and showing a past infection.

ELISA is possible with whole blood, serum or plasma in an EDTA tube.

## **3. Antigen detection**

Viral antigen can be detected in:

- Whole blood (ELISA)
- Skin snips (Immuno-histo-chemistry)
- Liver biopsy (Immuno-histo-chemistry)

Similar to the PCR test, the antigen detection test can have false negative results in the first 3 days after onset of symptoms. As with the PCR test, the sensitivity reflects the level of viraemia, and goes down when the viraemia drops upon recovery.



## **Annex 6. Sample collection: Transportation & IATA regulations**

The transport of Infectious substances outside a country is subject to strict ICAO (International Civil Aviation Organization)/IATA (International Air Transport Association) and UPU (Universal Postal Union) regulations concerning packaging, labeling and transport.

Further to the regular ICAO/IATA and UPU regulations on Infectious substances, there are also State Variations and Operator Variations. Due to frequently changing regulations, and the variations depending on operator and country, an exact description of the procedures is almost impossible. Verify with the medical department in headquarters and if possible with the WHO representative how to proceed for each specific case.

Samples should always be transported with the Triple Packaging System. To transport the sample outside a country also the IATA regulations should be followed.

### **Basic Triple Packaging System**

Samples have to be packed in three containers.

- Inner watertight container, containing the sample.
- A second watertight box, containing enough absorptive material surrounding the first box, in order to absorb all the fluids of the sample in case of leakage of first box.
- Outer shipping package that protects the secondary box from physical damage and water.

Specimen data forms, letters, and other information regarding the specimen, and identification of the shipper and consignee identification should be attached to the outside of the second container.

There are two boxes for Infectious substances (UN 2814) with the following MSF catalogue numbers:

- Cold chain: PPACUN62ISI
- Room temperature: PPACUN62IS-

### **Infectious Substances**

- Liquid Blood in vacutainer

! International air carriers strictly prohibit hand carriage, and the use of diplomatic pouches for transporting infectious substances.

### **Packaging**

The basic triple packaging must meet with the UN class 6.2 specifications and packaging instruction (PI) 602. The maximum net quantity of infectious substances in outer shipping package is 50 ml or 50g for passenger aircraft and 4L / 4Kg for cargo plane or other carriers.

### **Labelling**

A label with following information is required:

- Name, address, and telephone number of consignee.
- Name, address, and telephone number of shipper.
- UN number and proper shipping name.
- Packing list & pro forma invoice and airway bill (as described above).
- Temperature storage requirements (optional).

The infectious substance (biohazard) label must be put on the outer packaging. If packaging exceeds 50ml or 50g, two package orientation labels (arrows) indicating the UP side must be placed.

**Required shipping documents**

- The Shipper’s Declaration for Dangerous Goods.
- Packing list, pro-forma invoice, and air waybill (as described above).
- Copy of specimen data forms, letters, and other identification data.
  - One copy must be attached to the outside of the second container.
  - One copy to be sent (by airmail) to the receiving laboratory.
  - One copy stays with sender.

**Requirements for Air Mail**

Both Infectious Substances and Diagnostic Specimens may be shipped by registered airmail.

- Basic triple packaging system must conform to Infectious Substances requirements (UN 2814), IATA packaging 602.
- Green Customs Declaration Label for Postal Mail (international mail)
- Address label must display the word “LETTRE”
- Biohazard label and Shipper’s Declaration of Dangerous goods.

**Example of a ‘602 package’ for Infectious Substances, Category A (UN 2814)**

Source: WHO

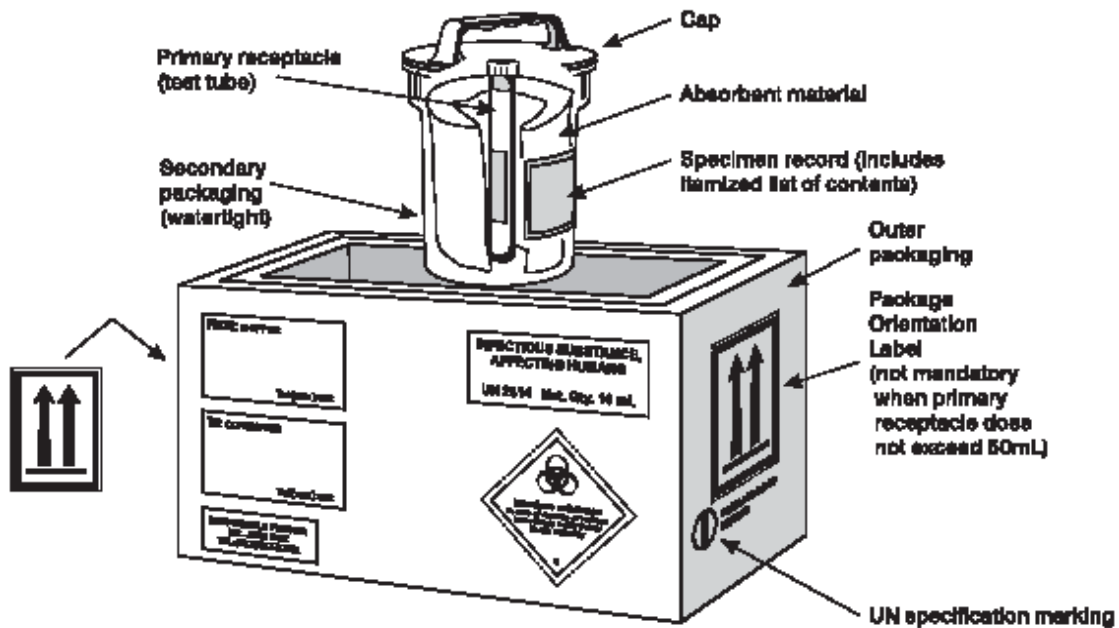

## Annex 7. Site assessment form for Health centers

<b>Date:</b>		<b>Observer:</b>	
Name of Health Centre:		District:	
Population served #:		# Beds/Patients:	/
Name - Medical officer:		Name - watsan/tech:	
FHF cases reported #:		Referred to:	
<b>Medical</b>			
Type of health structure?		Hours of operation:	
Services offered?			
# Beds & ratio beds/m <sup>2</sup>			
Attendance rate?			
Laboratory?	Y	N	N/A
Invasive procedures used?	Y	N	N/A
Minor surgery?	Y	N	N/A
<b>Infection Control</b>			
FHF Triage?	Y	N	N/A
Standard precautions?	Y	N	N/A
Disinfection and sterilization procedures?			
General hygiene: cleaning, laundry, etc.			
Availability of equipment and materials?			
Management of flow of patients, visitors, etc.			
<b>Excreta Disposal</b>			
Type of latrine?			
Walking distance?			
State of repair?			
# Latrines for patients?	Y	N	N/A
# Separate latrines for FHF patients?	Y	N	N/A
# Latrines for staff?	Y	N	N/A
Separation FHF latrines from other latrines?	Y	N	N/A
Possibility to increase # latrines?	Y	N	N/A
Access for elderly, disabled, children?	Y	N	N/A
Pit cover available/used?	Y	N	N/A
Flies seen?	Y	N	N/A
Functioning hand-washing facility?	Y	N	N/A
<b>Water Supplies</b>			
Type of supply?			
Pumping method?			
Protection measures?			

Walking distance?				
Quality of water?				
State of system?				
Water supply in HC?	Y	N	N/A	
Chlorination?	Y	N	N/A	
Water in dry season?	Y	N	N/A	
Used by community?	Y	N	N/A	
Distance from latrine?	Y	N	N/A	
<b>Waste Disposal</b>				
Type of facilities?				
Walking distance?				
Protective measures?	Y	N	N/A	
State of repair?	Y	N	N/A	
Segregation waste in HC?	Y	N	N/A	
Collection of waste in HC?	Y	N	N/A	
Disposed regularly?	Y	N	N/A	
Safe disposal of sharps?	Y	N	N/A	
Safe disposal of organic waste?	Y	N	N/A	
Safe disposal of solid waste?	Y	N	N/A	
Awareness FHF waste?	Y	N	N/A	
<b>Health &amp; Hygiene Promotion</b>				
# Health promoters?				
Facilities/messages being promoted?	Y	N	N/A	
Visible signs of promo?	Y	N	N/A	
Campaign messages put into practice?	Y	N	N/A	
Appropriateness?	Y	N	N/A	
Community participation?	Y	N	N/A	
Awareness of FHF?	Y	N	N/A	
<b>General</b>				
Location?				
Management of health structure?				
Facility to host patients?	Y	N	N/A	
Separation patients and FHF patients?	Y	N	N/A	
FHF training received?	Y	N	N/A	
State of building?				
State of inventory?				
Storage facility?	Y	N	N/A	
Source of patients' food?				
Bathing facility present?	Y	N	N/A	

## **Annex 8. Standards for providing samples in filovirus outbreaks with the laboratory in the country**

In outbreaks most of the times field laboratory facilities will arrive in the country once an outbreak is declared. Standards for providing samples to the field laboratory makes sure that the process of identifying the infectious agent will not have an unnecessary delay.

Often standard laboratory forms will be given by the laboratory facility. Many laboratories work with code numbers. Each patient, from who samples are taken, will have a sample code number.

### **Standards:**

From each patient, 2 specimens will need to be provided:

- Blood:
  - EDTA tube (purple cover), 2 ml
  - Dry tube (red cover), 2 ml
- Stool: stool may be included if differential diagnoses include enteric diseases (e.g. Shigella, Cholera, Typhoid) and should be collected in a sterile container. (The 'stool' containers are normally non-sterile, so better to collect stool in a sterile urine container.)
- Other specimens may be collected if appropriate, e.g. breast milk or semen.
- All tubes or containers will need to be labelled with patient's name and the sample code number.
- Sample tubes and containers will need to be put in triple layer packaging, with disinfection of each item, as explained in Chapter 2 and Annex 6.
- The 2 blood tubes from one patient can be put together in a plastic transparent bag, then after the tubes are put inside, the in- and the outside of the bag needs to be disinfected. The plastic bag with the 2 tubes will be put in the collection container as the 'first layer' with disinfection in and outside of the container. Then the container with the samples in the plastic bag will need to be put in the box and surrounded by absorbent cotton wool or paper, and then sprayed in and outside and closed. Then all the layers will be put in the 3<sup>rd</sup> layer: the carton box.
- Data to be collected for each sample will include:
  - Date sample was drawn + location + hour of collection
  - First and last name of person drawing the sample
  - First and last name, age, and sex of patient and the sample code number (should correspond to the name and sample code number on the label of the tube or container)
  - Living or deceased, date deceased
  - Hospitalized and where
  - Patient location
  - Patient symptoms
  - Presence of haemorrhage (from where)
  - Patient contact history with filovirus cases or sick persons
  - Date of onset of symptoms
  - Has this patient been previously tested? (yes/no – when)
  - Name of person to be contacted with results
- No sharps are to be included with the sample
- No visible blood or body fluids on packaging or data sheet
- Lids or seals will be securely closed



# Annex 9. Examples of lay out of Marburg/Ebola unit with different risk zones

Example 1. A theoretic example to be used to help to design the layout in a real set up.

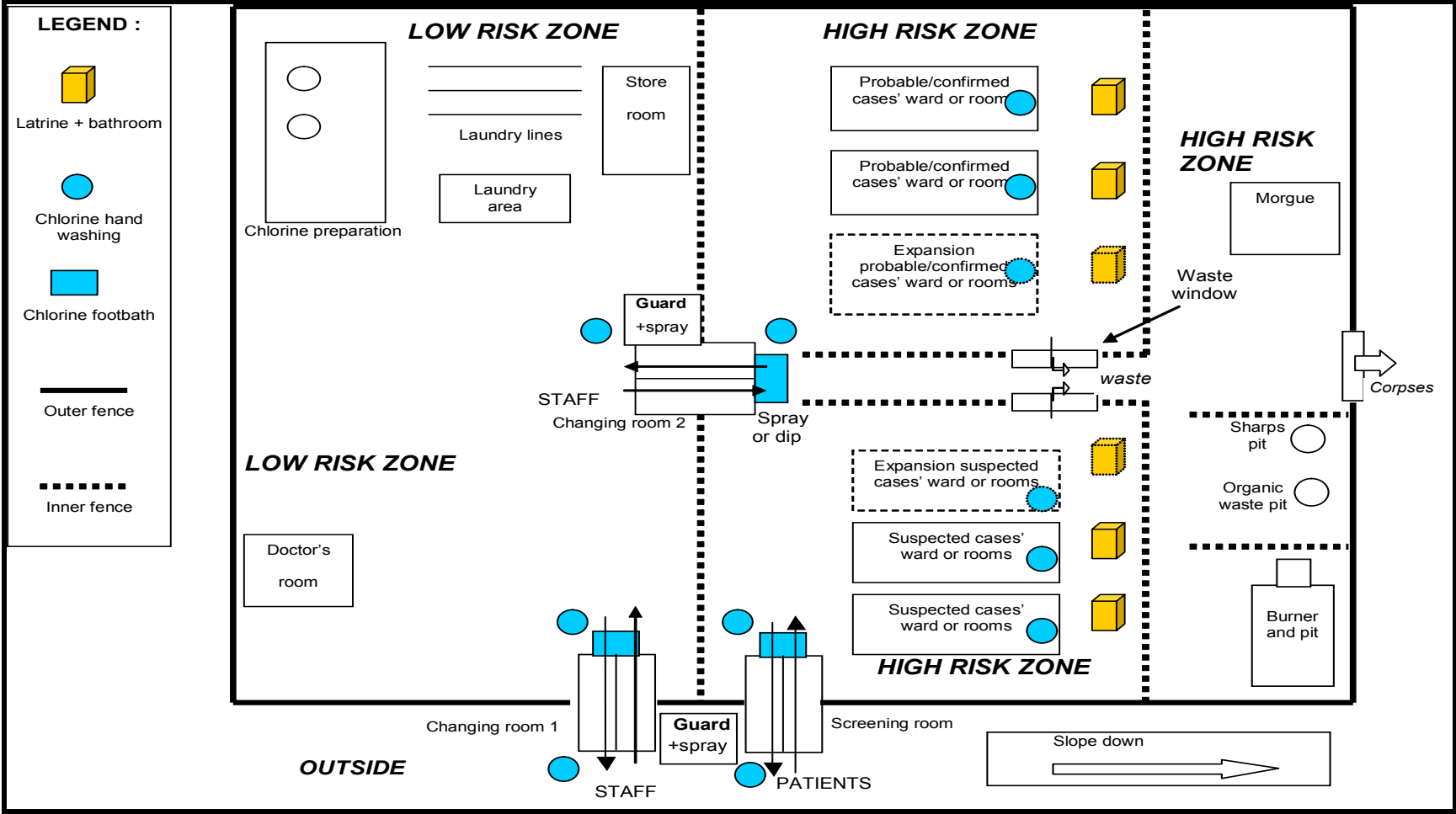

**Example 2. An example of a real layout used during an outbreak with a defined one-way patient flow**

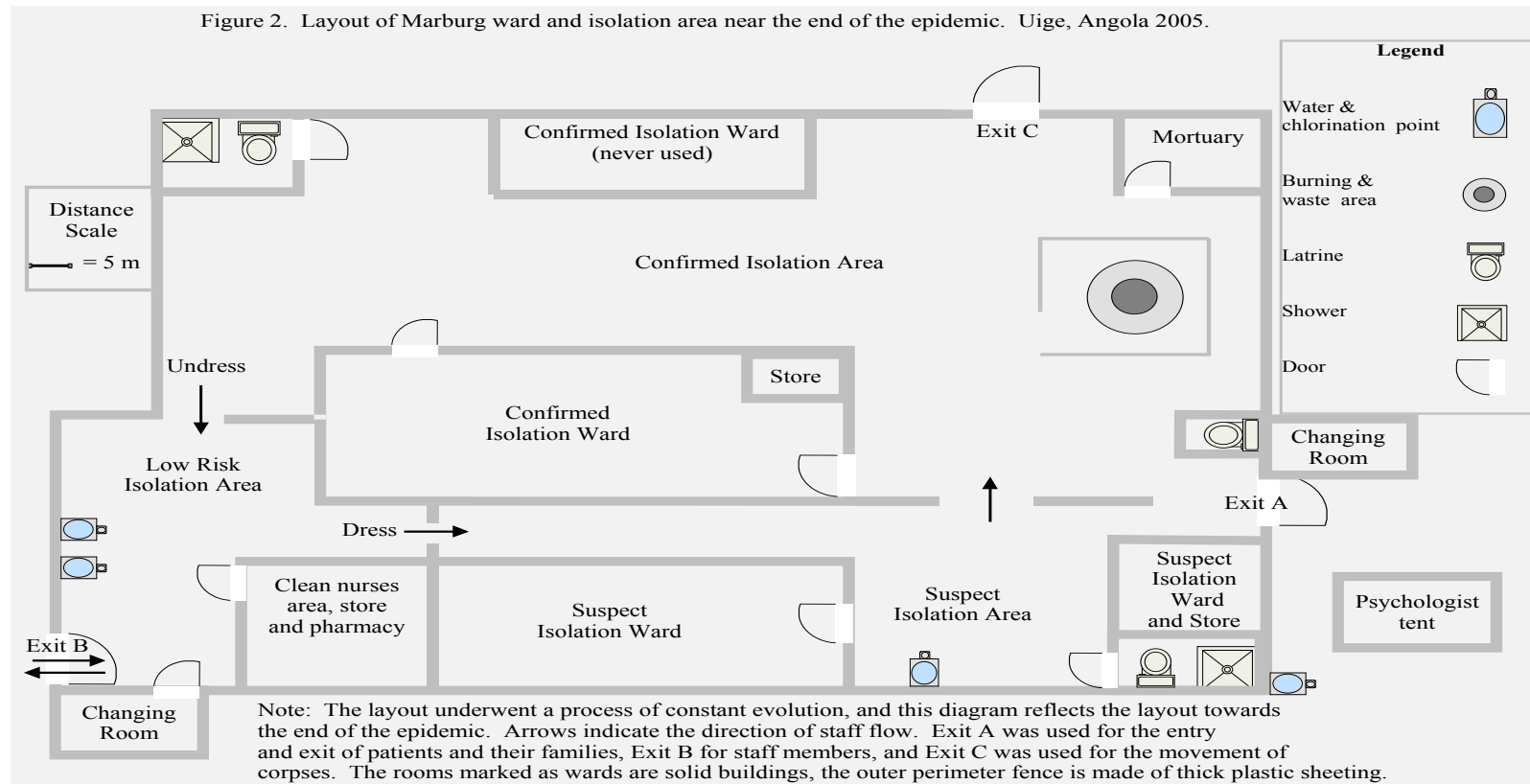

**Remark:** Dress and undressing area at exit A is not marked.



## Annex 10. Example of plan of Changing Rooms

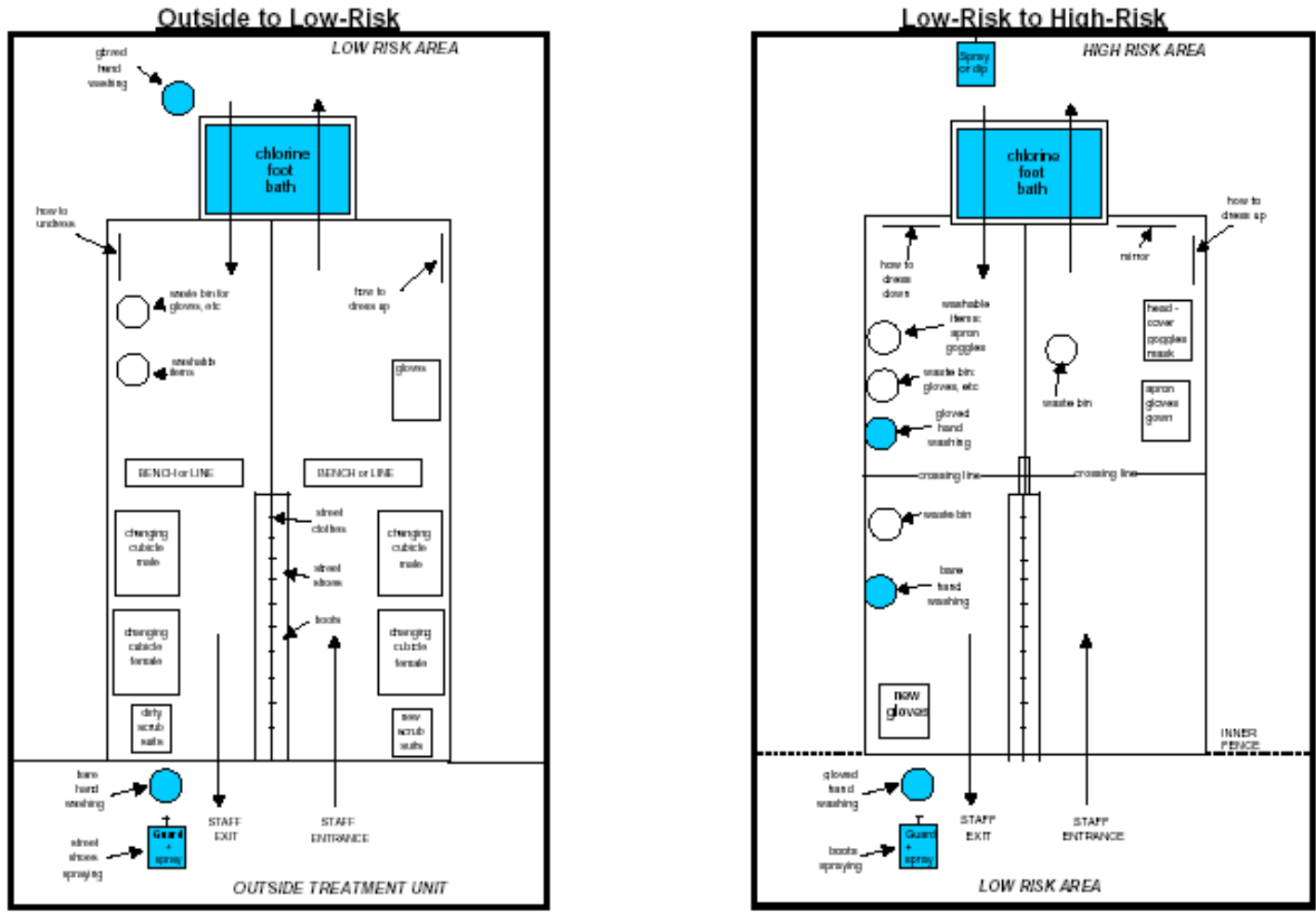

**Remark:** Each person is responsible to disinfect correctly his/hers apron and goggles, and hang them outside the changing rooms to dry in the sun.

## **Annex 11. Dressing and undressing protocols**

Slightly adapted protocols are used for those dressing and undressing outside the Marburg/Ebola unit. The main difference being that the reusable materials are disinfected then stored in covered buckets and transported to the Marburg/Ebola unit.

### **Dressing Protocol for Entering the Low-risk Zone**

When entering the low-risk zone, staff dresses up in the changing room according to the following procedure:

1. Remove street shoes and street clothes.
2. Put on one pair of gloves.
3. Put on scrub suit and your personal rubber boots. Tuck scrub suit into boots.
4. Go into the low-risk zone.

### **Undressing Protocol for Leaving the Low-risk Zone**

When leaving the low-risk zone, staff undresses in the changing room according to the following procedure:

1. Walk through chlorine footbath and have boots sprayed.
2. Remove boots using boot remover.
3. Remove gloves and dispose into waste bin.
4. Remove scrub suit and place in collection container for disinfection and washing.
5. Put on street shoes and street clothes.
6. Disinfect hands with 0.05% chlorine solution.
7. Spray soles of street shoes with 0.5% chlorine solution when exiting the changing room.

### **Dressing Protocol for Entering the High-risk Zone**

Inside the low-risk zone, all staff wears the following:

- One pair of gloves, scrub suit and rubber boots.

When entering the high-risk zone, staff dresses up in the changing room according to the following procedure:

1. Put on the overalls or gown.
2. Put on a second layer of gloves (can be done after the goggles if using cleaning or protection gloves).
3. Put on the mask.
4. Put on the head cover.
5. Put on the apron.
6. Put on the goggles.
7. Go into the high-risk zone.

Example of Dressing Procedure for Entering the High-Risk Zone  
(WHO/CDC Manual)

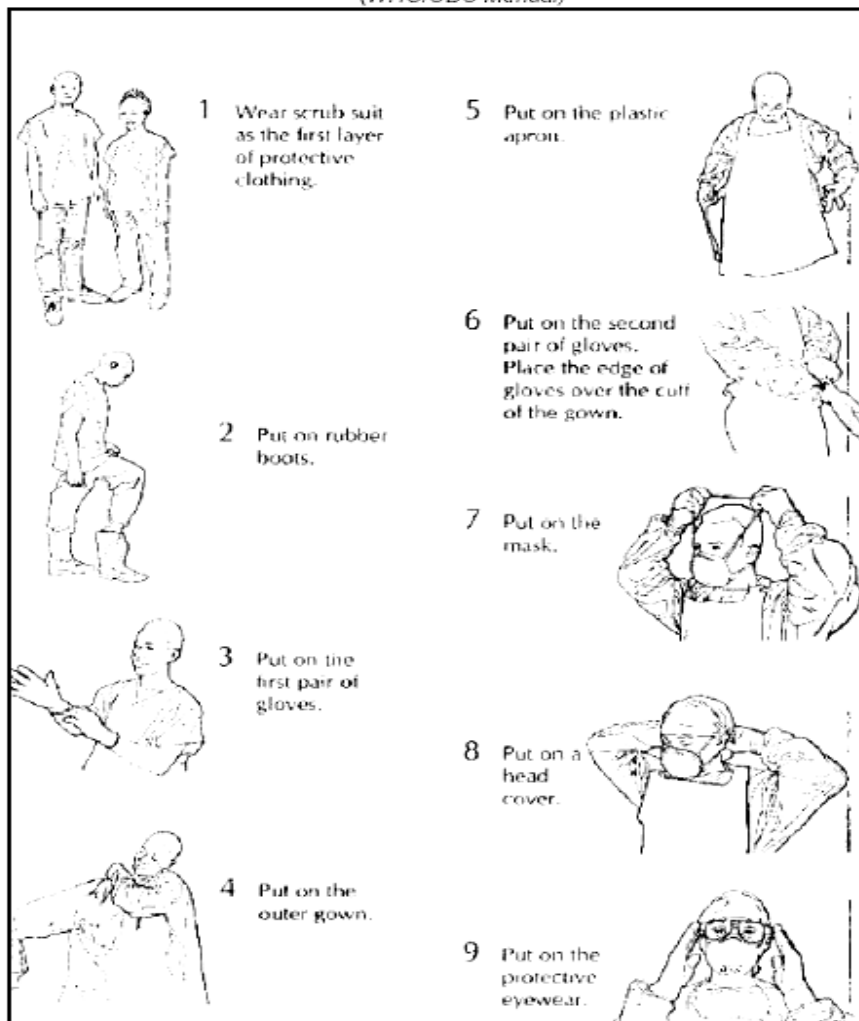

**Note: The apron (no. 5) should be put on after putting the head cover (no. 8) to ensure that the flaps of the head cover are put under the apron!!!!**

**Dressing Protocol for Leaving the High-risk Zone**

At the moment of writing a consensus is not yet reached about how to undress in the best way. Two examples are given of ways to undress:

- Example 1 is the safest way (most contaminated clothing removed first)
- Example 2 is seen as the most practical one (uncomfortable goggles removed as fast as possible, and thereby providing better vision and safety in the undressing)

The Water/Sanitation expert in the field will update the staff about the undressing procedures to be followed at the moment of the outbreak. Once started an undressing procedure, this procedure should not be changed during the intervention.

## Example 1 of Undressing Procedure for Leaving the High-Risk Zone



1. Disinfect the outer pair of gloves.



2. Disinfect the apron and the boots.



3. Remove the apron



4. Remove the outer pair of gloves.



5. Disinfect the gloved hands.



6. Remove the outer gown.



7. Disinfect the gloved hands.



8. Remove the goggles.



9. Remove the head cover.



10. Disinfect the gloved hands



11. Remove the mask.



12. Disinfect the gloved hands.

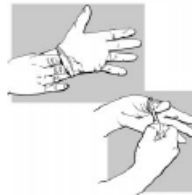

13. Remove the inner pair of gloves.



14. Wash hands with 0.05% chlorine solution, and put on new gloves.

## Example 2 of Undressing Procedure for Leaving the High-Risk Zone



1. Disinfect the outer pair of gloves.



2. Disinfect the apron and the boots.



3. Remove the apron



4. Remove the outer pair of gloves.



5. Disinfect the gloved hands.



6. Remove the goggles.



7. Disinfect the gloved hands



8. Remove the head cover.



9. Disinfect the gloved hands



10. Remove the outer gown.



11. Disinfect the gloved hands.



12. Remove the mask.

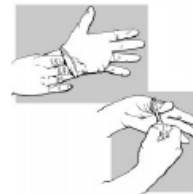

13. Remove the inner pair of gloves.



14. Wash hands with 0.05% chlorine solution, and put on new gloves.

## **Written instruction for Example 2 of Undressing Protocol for Leaving the High-risk area: (No consensus)**

1. Wash hands with 0.5% chlorine solution before heading to the disinfection and undressing area.

### **In the disinfection and undressing area:**

2. Disinfect gloved hands again with 0,5% chlorine solution.

3. Walk through chlorine footbath.

4. The Sprayer sprays the apron, front and back side.

5. Disinfect the apron again with chlorine 0,5% while pouring the solution over it with your hands. Immerse the apron in the container of 0,5% chlorine solution and after that in the second container 0.05% chlorine solution and hang it close to the second footbath.

6. Disinfect the outer pair of gloves with 0,5% chlorine solution.

A. If using surgical gloves: throw away in the waste bin.

B. If using household/ heavy-duty gloves: place in the bucket containing 0,05% chlorine solution.

7. Disinfect gloved hands with 0,5%.

8. Remove goggles, disinfect with 0,5% and rinse with clear water. Hang it close to the second footbath, next to the apron.

9. Disinfect the gloved hands with 0,5%.

10. Remove head cover and throw away in the waste bin.

11. Disinfect gloved hands with 0,5%.

12. Remove overall or gown and throw away in waste bin.

13. Disinfect gloved hands with 0,5%.

14. Step in the second footbath and let the Sprayer spray your boots.

15. Take goggles and apron to the dry area.

16. Remove the gloves and throw away in the waste bin.

17. Wash your hands with 0,05%.

18. Go into the Low-risk area and put a new pair of examination gloves.

## Annex 12. Preparation of chlorine solutions

Two chlorine solutions are used: 0.5% and 0.05%.

Instructions are given below on how to prepare the solutions using HTH granules with 65-70% active chlorine. Guidance is also given on the use of other products. The safety precautions necessary when handling chlorine products and solutions are also described.

**CAUTION!** Chlorine is a very aggressive and corrosive chemical. Always wear protective clothing (gloves, apron, mask, eye protection) when handling chlorine granules and strong solutions. Prepare chlorine solutions in a well-ventilated area, preferably in the open air. Use plastic containers and equipment for the preparation and storage of chlorine solutions.

### Preparing 0.5% and 0.05% Solutions with HTH-70% Chlorine Granules

Typically, large volumes of chlorine solutions must be prepared every day. Therefore, simplicity, ease, and convenience take precedence over trying to prepare a solution of precisely 0.5% or 0.05%. To this end, the following table gives the quantities of HTH required for the various volumes of the containers found in the kit. (The resulting solutions are slightly stronger than 0.5% and 0.05%)

Volume	0.5%	0.05%
10l bucket	5 spoons*	½ spoon*
20l bucket	10 spoons*	1 spoon*
60l (half 120l container)	1 x 500g pot	3 spoons*
120l container	2 x 500g pot	6 spoons*

\*Spoons are those found in the kit or soup spoon sized

### Preparation

1. Fill the container with clean water.
2. Pour in the required amount of HTH and stir well.
3. Allow the white sludge to settle and use the resultant clear liquid.
4. Every time the container is refilled, the white sludge should be discarded into a soak away or sewer.

### Preparing Solutions with NaDCC Tablets (1.5g active chlorine)

The 1.5g tablets can be used for preparing small quantities of solutions.

Volume	0.5%	0.05%
10l bucket	35 tablets	3.5 tablets
20l bucket	28 tablets	7 tablets

### Storage

Chlorine products and solutions are weakened through exposure to air, sunlight, and heat.

- Store products and solutions in closed plastic or plastic lined containers.
- Store products and solutions in a cool, shaded (ideally dark) area.

### Other Products

HTH is the recommended chlorine product to use as it is very stable and the percentage strength is not affected as readily as with other products. However, in certain circumstances it may be necessary to use products other than HTH-70% for the preparation of chlorine solutions. However, the percentage strength of the product **must** be known.

This can be tested at a lab *or*

- If relying on the manufacturers factory design strength then:
  - The products must be no older than 3 months.
  - The storage and transportation history of the product should be known.

Once the percentage strength of the chlorine product is known, the following formula can be used to calculate the dilution proportions for preparing the chlorine solutions.

$$\text{Quantity of chlorine product (g)} = \left( 10 \times \left( \frac{100}{\text{product strength (\%)}} \right) \right) \times \text{solution strength required (\%)} \times \text{volume required (l)}$$

For example, to prepare 120l of 0.5% solution with household bleach at 4% strength.

$$\begin{aligned} \text{Quantity of household bleach (g)} &= \left( 10 \times \left( \frac{100}{4 (\%)} \right) \right) \times 0.5 (\%) \times 120 (l) \\ &\Rightarrow 10 \times 25 \times 0.5 \times 120 \\ &\Rightarrow 15000\text{g or } 15 \text{ litres of household bleach} \end{aligned}$$

### Precautions

- Always wear rubber boots, an apron, and gloves when handling 0.5% solution.
- Try not to splash.
- Be very careful with eyes and skin since the solution is very aggressive.
- When applied on metal objects (cars, etc) rinse at least 3 times with clean water.
- Solution should not be kept more than 24 hours.
- If solution is more than one day old, dispose of it in a soakaway or latrine.

### Maintaining Chlorine Sprayers

The sprayers used for chlorine solutions must be maintained regularly.

- Some parts of the sprayers are metallic and corrode when in contact with chlorine solutions.
- The calcium in the HTH granules can solidify and block the pipes and fittings.

### Procedure

- Empty the sprayer of any remaining chlorine solution.
- Rinse with water (spray clean water to rinse the inside of the pipes), and empty out the water.
- Dismantle the main parts of the sprayer – pipes, nozzles, etc.
- Put all small parts in a container of pure vinegar, let soak for 5 min. and brush with toothbrush.
- Fill 1/3 of the reservoir with clean water; add 1l of vinegar, shake, and let soak for 15 minutes.
- Check sprayer parts and fittings for damage, and repair as required.
- Reassemble the sprayer; spray the vinegar solution on all outside parts to remove any calcification.
- Empty any remaining vinegar solution.
- Rinse with clean water (spray some clean water to rinse the inside of the pipes).
- Refill with chlorine solution.

### Frequency

- Rinse every 2 days using plain water and clean once per week with vinegar as described.

### Material Required

- Clean water, vinegar, tooth brush and a small plastic container.



## **Annex 13. Cleaning and disinfection of Protective Equipment**

Items that require routine and regular disinfection, cleaning and/or laundry are:

- Aprons, goggles, scrub suits, boots, reusable gloves

### **Disinfection of Aprons**

- Spray apron before removal with 0.5% chlorine solution.
- Dip in bucket of 0.5% chlorine solution for 3 minutes and then scrub.
- Dip in bucket of fresh 0.5% chlorine solution.
- Rinse with clean water.
- Hang to dry.

The apron could be left for a longer period in the chlorine solution if particularly dirty, but do not leave to soak for too long to avoid damaging the apron.

### **Disinfection of Goggles**

- Place goggles under a flow of 0.5% chlorine solution for a few seconds, and ensure that all parts of the goggles have been soaked in the solution.
- **Rinse with clear water!!**
- Hang to dry, preferably in the sun.

Each user is responsible for ensuring that their goggles are disinfected and clean before putting them on.

### **Disinfection of Scrub Suits and Laundry**

- Put scrub suits in fresh 0.05% chlorine solution.
- Leave to soak for 30 minutes.
- Rinse twice with clear water.
- Wash with detergent and fresh water.
- Rinse with clear water.
- Hang to dry in the sun.

### **Cleaning and Disinfection of Boots**

- Put boots in fresh 0.05% chlorine solution.
- Leave to soak for 30 minutes.
- Rinse twice with clear water.
- Dry upside down on sticks driven into the ground.

### **Disinfection of Reusable Gloves**

- Household gloves and heavy-duty gloves can be reused after disinfection and cleaning.
- Soak in 0.05% chlorine solution for 30 minutes.
- Rinse twice with clean water.
- Fill gloves with water and squeeze to check for any leaks.
- Dry on sloping racks or on sticks driven into the ground.

## Annex 14. Waste management: waste definitions, collection, transport and disposal

Type of Waste	Definition and Examples	Collection	Transport	Disposal
<b>Burnable waste</b>	<p><b>Dry waste</b> is all waste that has low moisture content and is therefore easily burnt. Examples are dressings, packaging, paper, used protective clothing (gowns, gloves, etc), etc.</p> <p><b>Wet waste</b> is waste that has high moisture content. In practice, mainly contaminated waste that has been disinfected with chlorine (clothes, mattresses, etc).</p>	<p>To reduce the risk of leaks, 2 bags, one inside the other, should be used to collect both wet and dry waste.</p> <p>Burnable waste is collected in doubled plastic garbage bags. The bags should be supported in a garbage-bag-holder. When the double bag is ¾ full, collect it and close with a string or tape. Disinfect the outer bag. Put new double bags in the bin immediately.</p>	<p>The waste worker must promptly transport the bag(s) to the waste area.</p> <p>The bag(s) can be carried in a wheelbarrow to reduce the risk of the bag splitting and possible contamination of the compound.</p>	<p>Bags must be burned without opening them. Assist burning with paraffin or diesel as necessary.</p>
<b>Liquid waste</b>	<p>Examples are body fluids: vomit, soft stools, urine, blood, etc). Body fluids can be excreted in two ways:</p> <p style="padding-left: 40px;">In a controlled way (into a bucket); In an uncontrolled way (spills on floor, bed, clothes, etc).</p>	<p>Controlled: Collect waste in a bucket with 2cm of 0.5% chlorine solution. When waste has been excreted, add enough 0.5% solution to cover completely the waste Allow minimum of 15 minutes for chlorine to act. Uncontrolled spills: Pour 0.5% solution directly on the spill without splashing. Leave for 15 minutes. Mop up with an absorptive pad or towel. Place the waste into a bucket.</p>	<p>Transport the covered bucket to the latrine without splashing or spilling.</p>	<p>Liquid waste can be disposed of into a special <b>liquid waste pit or into a pit latrine.</b></p> <p>The soaked pads should be disposed of into a pit latrine (never into a flush toilet!), or into the waste pit / burning pit.</p>
<b>Organic waste</b>	<p>Organic waste originating from the human body: placentas, body parts, etc. Other organic waste e.g. food leftovers.</p>	<p>Organic waste originating from the human body is a huge biohazard and must be disposed of immediately.</p> <p>Organic waste can be collected in a double plastic bag or bucket. Close the bags with a string or tape. Disinfect the outside of the bag or bucket.</p>	<p>The bags or buckets must be taken immediately to the waste zone.</p>	<p>Organic waste can be disposed of in a specially built <b>organic waste pit</b> or if not available, a pit latrine can be used.</p>
<b>Sharps</b>	<p>Items that can cause cuts or puncture wounds, including needles, scalpels, knives, infusion sets, saws, broken glass, nails, etc.</p>	<p>Sharps containers must be – waterproof, puncture resistant, and clearly marked “SHARPS”.</p>	<p>Disinfect outside of the sharps container before transporting.</p>	<p>Sharps pit.</p>
<b>Waste water</b>	<p>Run off water: rainwater from the roof, or compound. Wastewater: water used for cleaning, from foot baths, used chlorine solutions, etc.</p>	<p>Avoid that run off water flows out of higher risk into lower risk areas. Wastewater must be channelled to, and disposed of in a soak away.</p>	<p>Direct run off water and wastewater to separate gutters, ideally lined with concrete or cement mortar.</p>	<p>Run off water and wastewater has to be controlled and directed to safe disposal areas. If wastewater is disposed of in a soak away, a grease trap should be installed. The grease trap must be thoroughly disinfected before cleaning.</p>

## **Annex 15. Caretaker Task Instruction HBSRR and HBSRR kit**

### **Dressing and Undressing**

- The caretaker dresses up outside under supervision.
  - Order: examination gloves, shoe covers (or boots), then gown, then mask, then cleaning gloves or disposable surgical gloves, then apron, and then goggles.
- The caretaker undresses outside at the door under supervision. Order:
  - Wash hands with 0.5% chlorine solution,
  - Disinfect the apron, remove it and place it in the bucket containing 0.5% solution
  - Take off the shoe covers and place it in the rubbish bag.
  - Wash hands with 0.5% chlorine solution
  - Take off the gown and place it in the rubbish bag.
  - Wash hands with 0.5% chlorine solution
  - Take off the goggles and disinfect in the bucket containing 0.5% chlorine solution.
  - Rinse goggles with clean water and hang to dry.
  - Take off the facemask and place it in the rubbish bag.
  - Wash hands with 0.5% chlorine solution.
  - Take off the gloves and dispose if surgical gloves or place them in the bucket containing 0.5% chlorine solution if cleaning gloves, then hang them to dry.
  - Wash hands with 0.05% chlorine solution.
  - Take of and dispose examination gloves.

### **Give the Drugs**

- Give the drugs according to the timing written on the prepared drug bags.
- Ensure that the patient takes all the pills. If the patient cannot swallow, crush the pills and mix with some liquid.
- It is forbidden to give injections, IV treatment, or traditional medicines.

### **Provide the Food**

- Ask the patient to bring his plate to the door and spoon the food into it without touching.
- If the patient cannot walk, the caretaker dresses and enters the room, and brings the plate to the door where another family member spoons the food into it without touching.

### **Wash the Clothes and Utensils**

- Before entering the room, put a bucket half filled with 0.05% chlorine solution outside the door.
- Carefully place the dirty clothes or utensils into the bucket without leaving the room or touching the bucket.
- After 30 minutes, the bucket can be removed. The contents must be rinsed and washed with soap.
- Put clothes in the sun to dry.

### **Wash the room**

- If vomit or excreta are on the bed or on the floor, pour one cup of 0.5% chlorine solution over it. Leave it for at least 15 minutes and then mop up with the absorbent pad (green plastic side up).
- The mattress must be covered with the plastic sheeting provided. The sheeting can then be washed with an absorbent pad soaked with 0.5% chlorine solution.

### **Disposal of faeces**

- Pour 1 cm of 0.5% chlorine solution into the bucket.

- After use pour another cup of 0.5% chlorine solution over the contents and put the lid on.
- Disinfect the outside of the bucket with 0.5% chlorine solution and place it outside the door. Leave the bucket for at least 15 minutes, and once undressed and outside the room again, put on clean gloves and pour the contents carefully into the latrine
- Disinfect the latrine once a day with 0.5% chlorine solution.

#### **Disposal of waste**

- All waste has to be placed in a rubbish bag,
- When the bag is half-full, close the bag and disinfect the outside with 0.5% chlorine solution, place it outside the door.
- Once undressed and outside the room again, burn the bag in the burning pit.

#### **What the family should do if the patient dies**

- Do not touch the body or any of the patient's belongings.
- Close the door of the room.
- Inform the mobile team coordination.
- Wait for the decontamination and burial teams to arrive.

### **HBSRR kit**

#### **Example of HBSRR kit:**

Apron	1
Pair of goggles	1
Single use gowns	6
Shoe covers	10
Examination gloves	1 box
Pairs of cleaning gloves (or surgical gloves-disposable )	2 (10)
Face masks	10
Rubbish bags	6
Plastic jerrycans with taps (chlorine solutions)	2
Different type of doses of HTH for preparation of 0.5% and 0.05% chlorine solution	2
Bottle (ORS preparation)	1
Potty	1
Buckets	2
Piece of plastic sheeting 2m-2m	1
Soaking pads	5

Reusable items need to be replaced regularly.

## **Annex 16. Information for patients, discharged patients and relatives.**

To complement the briefings and explanations that must be done for all admissions and their relatives, information sheets translated into the appropriate languages can be provided. If they are unable to read, the sheets should still be provided with the contents explained verbally. Information sheets using pictograms illustrating the most important aspects can also be prepared. The information can also be presented as posters in, and at the entrance to the Marburg/Ebola unit.

### **Information For New Admissions To The FHF Treatment Unit**

Welcome. You have been admitted to the FHF Treatment Unit. This means that a doctor has examined you and thinks you may have Ebola/Marburg disease.

It is important to stop Ebola/Marburg from spreading to other people including friends, family or health staff. Some ways to do this are:

- Avoid unnecessary contact with other people.
  - Only one visitor per day for X hours.
- Staff and visitors will wear protective clothing.
  - Mask, gloves, gown, apron, and boots.
- No personal items are allowed to leave the unit.
  - Do not pass items over the fence, e.g. plates, pots, blankets, etc.
- Do not touch or close to unprotected people.
  - Stay at least 1 meter from the fence if talking to someone.
- Remain in the unit until your treatment is finished.
  - You will be discharged when the doctor decides that you cannot infect other people.

You will receive a kit of material upon arrival. This is for your use and should not be shared or given to other people. The kit includes a plate, cup, sheets, drinking bottles, plastic bags, absorbent pads, soap, and a thermometer with holder.

Whilst in the unit, you should try to drink as much water and fluids as you can, eat healthily and walk around inside the unit when possible.

If you have any questions, or concerns please discuss them with the staff.

### **Leaving the FHF Treatment Unit**

The doctor has examined you, and it is now safe for you to go home or to be transferred to the main hospital. This means that you will not infect other people with Ebola/Marburg.

Before leaving the unit:

- The cleaning team will clean and disinfect all your personal items.
- Blankets CANNOT be taken from the unit. We will provide you with new items if you brought your own.
- You will need to arrange for a fresh set of clothes to be brought to the unit for you to wear when you leave. Your other clothes will be cleaned and may be collected the following day.

Take all medication as prescribed by the doctor.

### **When You Are at Home**

After recovery, you may still feel weak for 1 to 2 months.

It is important to:

- Take plenty of rest.
- Eat a mixture of foods e.g. bread, vegetables, fruit, meat, beans.
- Take the multivitamin tablets provided for one month.
- Drink as much water as you can

If you get sick, especially if you have fever, you should go to a health facility for examination and treatment.

Note: If you are male there is a possibility of transmitting Ebola/Marburg during sexual intercourse, you should abstain, or use condoms for 3 months after discharge.

### **Advice to Relatives**

Your friend or relative has just been admitted to the FHF Treatment Unit. This is to help them receive treatment, to prevent you from becoming sick, and to avoid infecting other people as well.

We ask for your assistance and cooperation in observing the following regulations to help us to fight this disease.

- Only one relative may enter the unit, ? times per day, for ? hour(s).
- When visiting the use of the protective material will be explained, and you must wear the material that is supplied to you.
- Do not touch the patient.
- Do not touch infectious material e.g. vomit, diarrhoea, beds, cups or spoons.
- Do not eat or drink anything inside the unit.
- When leaving the Unit, the method to remove of the protective material will be explained, and you must remove all of the protective material.
- Always wash your hands and spray your feet when leaving the unit and when asked to do so.

*Adapt as required.*

## Annex 17. List for patient items provided at admission.

Each patient admitted to the Marburg/Ebola unit must be provided with the following items.

Patient Items Provided at Admission		
	Quantity	Item
1	1	Mattress covered with heavy-duty plastic sheeting.
2	1	Bed sheet and/or blanket.
3	1	Bucket for bathing and laundry.
4	1	Bucket with lid for collecting liquid waste (vomit, spills, etc.).
5	1	Plastic plate.
6	1	Spoon.
7	1	Large plastic cup for drinking.
8	1	1 - 1½ l bottle for drinking water or ORS.
9	1	Roll of toilet paper.
10	1	Bar of soap.
11	5	Absorbent pads.
12	1	Towel
13	2	Small towels
14		

*Modify the checklist according to the context.*

**Remark:** Buckets with different colors should be used to avoid confusing: e.g. use a red colored bucket for liquid waste (all patients) and a blue colored bucket for bathing and laundry.

### **Additional item for patients on IV fluids.**

Plastic bag for collecting empty IV fluid bags as a record of IV fluid intake. Suspend bag on end of the bed.

⇒ This bag must not be used for rubbish, needles, or sharps.

## Annex 18. Examples of medical and epidemiological forms

### 18.1 Triage form

Patient name:			Date:
Sex:	M	F	Age: Register no.:
Address/Location:			
Reason for consultation:			
Date illness started:			
Did patient receive treatment before coming to the hospital?			Yes No
What kind of treatment? _____			
Where did patient receive treatment? Hospital/Health centre (name): _____			
Traditional healer: _____ Other _____			

#### FHF symptoms presented:

Fever	Yes	No	# days: _____	Temperature: _____°c.
Headache	Yes	No		
Nausea	Yes	No		
Vomit	Yes	No	Bloody	Yes No
Diarrhoea	Yes	No	Bloody	Yes No
Haemorrhagic eyes	Yes	No		
Other haemorrhage	Yes	No	Location	_____
Breathlessness	Yes	No		
Bone/muscle pain	Yes	No		
Loss of appetite	Yes	No		
Asthenia/weakness	Yes	No		
Abdominal pain	Yes	No		
Jaundice	Yes	No		
Swallowing problems	Yes	No		
Hiccups	Yes	No		

#### Contact history in last 21 days

Is there somebody ill in the family?	Yes	No
Have you visited someone who is ill?	Yes	No
Has somebody died recently in your family	Yes	No
Have you been to a funeral recently?	Yes	No

<b>Suspicion of FHF</b>	<b>Yes</b>	<b>No</b>
-------------------------	------------	-----------

#### Patient Plan

Medicine ward		Adult emergency	
Orthopaedic ward		Paediatric emergency	
Surgery ward		FHF ward	
Maternity ward		Health centre	
Paediatric ward		At home	

#### Remarks:

Name of nurse/doctor:
-----------------------



## 18.2 Medical admission and Epidemiological Form

Person filling form: _____	Name of FHF ward _____
Information provided by: _____	Identification no. _____
Admission date: ___/___/___	

### Referral

Case referred by: Epi team	Health Centre	Other:
Family contact person: _____		

### Identity of the Patient

Name: _____	Surname(s): _____	
Age – years: _____	months: _____	Date of birth: ___/___/___
Sex: M F	Pregnant? Yes No	
Ethnicity and Language: _____		
Religion: _____		
Residence:		
Head of family (name/surname): _____		
Community/District of residence: _____		
Address/Location: _____		
Profession/Activities:		
Farmer	Hunter	Housewife
Miner	Shopkeeper	Child/Student
Other	What: _____	
Health worker	Type: _____	
Institution/Location of Health facility: _____		

### Funeral attendance

Has the patient been to a funeral in the last 21 days?	Yes	No
Did they touch or manipulate the body?	Yes	No
Name of deceased: _____	Date of funeral: ___/___/___	

### Medical Treatment Received in the last 21 days

Has patient received medical treatment in the last 21 days?	Yes	No	
Date(s) that this treatment was received: _____			
What treatment was received:	Injection	Tablets	Other (herbs, cuts, enemas, etc.)
Where was treatment received:	Hospital	Private Clinic	Traditional Healer
	Other	Location:	

**Contact with FHF Patients**

Has the patient had contact with someone with FHF or someone who has been ill recently?				
Name of FHF patient	Relationship	Date of contact	Symptoms	Type of contact*
<p>*In case of contact with someone with FHF (or probable FHF), what was the closest contact:</p> <p>1 - Slept in same house within the last 21 days.</p> <p>2 - Had direct physical contact.</p> <p>3 - Touched their body fluids (excreta, vomit etc.)</p> <p>4 - Had sexual relations.</p> <p>5 - Handled clothes or other personal objects.</p> <p>6 - Suckled patient or breast-fed from patient.</p> <p>7 - Contact with body at a funeral</p> <p>8 - Contact with the mattress, clothing or coffin of body during funeral practices.</p> <p>(Not including contact with rope for lowering the coffin nor touching earth during burial.)</p>				

**Contact with dead or sick non-human primates (gorillas, chimpanzees, monkeys)**

Has patient had any physical contact with a dead or sick non-human primate in the last 21 days?	
Yes	No
What kind of contact did the person have:	
What kind of animal?	

**Details of the Illness**

When did the illness start?	Date: ___/___/_____	# of days?	_____
Have they had fever during the illness?	Yes		No
→When did the fever start?	Date: ___/___/_____	# of days?	_____
Have they had vomiting during the illness?	Yes		No
Have they had diarrhoea during the illness?	Yes		No
Have they had bleeding during the illness?	Yes		No
→When did bleeding start?	Date: ___/___/_____	# of days?	_____
If there is a time difference between onset of symptoms, and seeking help, explain why?			

**Current Symptoms**

Fever on admission?	Yes	Temperature _____°C	No
<b><u>Non-Bleeding Symptoms:</u></b>			
Headache	Yes	how many days? _____	No
Bone or muscle pain	Yes	how many days? _____	No
Stomach pain	Yes	how many days? _____	No
Weakness	Yes	how many days? _____	No
Anorexia	Yes	how many days? _____	No
Swallowing problems or pain	Yes	how many days? _____	No
Nausea	Yes	how many days? _____	No
Vomiting	Yes	how many days? _____	No
Diarrhoea	Yes	how many days? _____	No
Breathlessness	Yes	how many days? _____	No
Red or injected eyes	Yes	how many days? _____	No
Non-haemorrhagic rash	Yes	how many days? _____	No
Hiccups	Yes	how many days? _____	No
<b><u>Bleeding Symptoms:</u></b>			
Cutaneous bruising / Petechia	Yes	how many days? _____	No
Cutaneous bleeding/injection sites	Yes	how many days? _____	No
Bleeding gums	Yes	how many days? _____	No
Diarrhoea with black or red blood	Yes	how many days? _____	No
Haematemesis (bloody vomit)	Yes	how many days? _____	No
Epistaxis (nose bleeds)	Yes	how many days? _____	No
Vaginal Bleeding	Yes	how many days? _____	No
Haemoptysis (coughing blood)	Yes	how many days? _____	No
Other symptoms:			
Other relevant medical history:			
Other findings:			

**Diagnosis at assessment for admission**

Suspect	Probable	Confirmed
Not Case		
If not a FHF case, what is the diagnosis? _____		

**Management/Admission**

FHF Treatment Ward	Other hospital service
HBSRR	For Home Based Support and Risk Reduction:
Name of caregiver: _____	Location: _____

**Laboratory Tests**

Date	Sample Type	Test Type	Result

**Final Diagnosis**

Suspect	Probable	Confirmed
Not Case		
If not a FHF case, what is the diagnosis? _____		

**Outcome**

Died	Recovered	Transferred	Fled
Comments: _____			

**Burial**

Who conducted the burial?	
Family	Mobile team MSF
Other	Who? _____

**Remark:**

The Medical Admission Form and the Epidemiological Form are put together because most of the information asked in the Epidemiological Form could be transferred from the Medical Admission Form.

### 18.3 FHF Patient Observation Sheet - Part 1 Symptomatology

<b>Family name:</b>		<b>DD / MM / YYYY</b>	
<b>First name:</b>		<b>Onset of symptoms:</b> /     /	
<b>Identifier No.:</b>		<b>Date of admission:</b> /     /	
<b>Age:</b>	<b>Sex:</b>	<b>Date of discharge:</b> /     /	

Adm = day of admission

Day	Adm	2	3	4	5	6	7	8	9	10	11	12	13	14
<b>Symptoms (check all that apply)</b>														
Headache														
Asthenia (severe weakness)														
Myalgia														
Arthralgia														
Hiccups														
Anorexia														
Nausea														
Vomiting														
Sore throat/ difficulty swallowing														
Stomach pain														
Tender abdomen														
RUQ pain														
Diarrhoea														
Anuria														
Dyspnoea														
Cough														
Chest pain														
Back pain														
Jaundice														
Non-haemorrhagic rash														
Hepatomegaly														
Splenomegaly														
Dehydration														
Disorientation														

<b>Haemorrhagic signs</b>														
Red or injected eyes														
Epistaxis														
Gingival/oral bleeding														
Haemoptysis														
Haematemesis														
Bloody stools														
Haematuria														
Non-menstrual vaginal bleeding														
Bleeding from injection site														
Petechiae or cutaneous bruising														

<b>Any other symptoms</b>														

**FHF Patient Observation Sheet - Part 2 Vital signs and Treatment schedule**

Adm = day of admission

<b>Date days 1-4</b>	____ / ____ / ____			____ / ____ / ____			____ / ____ / ____			____ / ____ / ____		
	AM	Noon	PM	AM	Noon	PM	AM	Noon	PM	AM	Noon	PM
<b>Day</b>	<b>Adm</b>	<b>Adm</b>	<b>Adm</b>	<b>2</b>	<b>2</b>	<b>2</b>	<b>3</b>	<b>3</b>	<b>3</b>	<b>4</b>	<b>4</b>	<b>4</b>
Temperature °C												
Pulse												
Respiration												

<b>Treatment</b>												

<b>Date days 5-8</b>	____ / ____ / ____			____ / ____ / ____			____ / ____ / ____			____ / ____ / ____		
	AM	Noon	PM	AM	Noon	PM	AM	Noon	PM	AM	Noon	PM
<b>Day</b>	<b>5</b>	<b>5</b>	<b>5</b>	<b>6</b>	<b>6</b>	<b>6</b>	<b>7</b>	<b>7</b>	<b>7</b>	<b>8</b>	<b>8</b>	<b>8</b>
Temperature °C												
Pulse												
Respiration												

<b>Treatment</b>												

<b>Date days 9-12</b>	____ / ____ / ____			____ / ____ / ____			____ / ____ / ____			____ / ____ / ____		
	AM	Noon	PM	AM	Noon	PM	AM	Noon	PM	AM	Noon	PM
<b>Day</b>	<b>9</b>	<b>9</b>	<b>9</b>	<b>10</b>	<b>10</b>	<b>10</b>	<b>11</b>	<b>11</b>	<b>11</b>	<b>12</b>	<b>12</b>	<b>12</b>
Temperature °C												
Pulse												
Respiration												
<b>Treatment</b>												

<b>Date days 13-16</b>	____ / ____ / ____			____ / ____ / ____			____ / ____ / ____			____ / ____ / ____		
	AM	Noon	PM	AM	Noon	PM	AM	Noon	PM	AM	Noon	PM
<b>Day</b>	<b>13</b>	<b>13</b>	<b>13</b>	<b>14</b>	<b>14</b>	<b>14</b>	<b>15</b>	<b>15</b>	<b>15</b>	<b>16</b>	<b>16</b>	<b>16</b>
Temperature °C												
Pulse												
Respiration												
<b>Treatment</b>												

**Note:** if longer than 16 days, re-create chart for day 17 onwards....





### 18. 4 Contact Tracing Form

Contact Tracing Form																					
<b>Team</b>																					
<b>Name of patient</b>											<b>Sex</b>	M	F	<b>Age</b>							
<b>Name of contact</b>											<b>Address / Location</b>										
<b>Village Leader</b>											<b>Community / District</b>										
<b>Type of contact in last 21 days</b>	1. Slept in same house					3. Touched body fluids					5. Breastfeeding					6. Funeral attendance					
<b>Date of last contact</b>	___ / ___ / ___																				
<b>Day and date of follow-up</b>																					
	...	...	...	...	...	...	...	...	...	...	...	...	...	...	...	...	...	...	...	...	
	1	2	3	4	5	6	7	8	9	10	11	12	13	14	15	16	17	18	19	20	21
Fever																					
Painfull muscles or joints																					
Weakness																					
Vomiting or nausea																					
Diarrhoea																					
Headache																					
Painfull throat or swallowing																					
Red eyes																					
Any haemorrhagic sign																					
Others:																					

## Annex 19. Solidarity kit

The Solidarity Kit is distributed to FHF patients upon their return home, or to their families in the event of their death. The contents of the kit are intended to replace those items that have probably been destroyed due to their admission in the FHF Treatment Ward, and during the house disinfection activities. Other objectives of distributing the kit include:

- Prevention and protection: direct access to recent contacts of the victims allowing early detection of potential FHF cases.
- Psychological care: provide essential care to victims of the epidemic.
- Community sensitization: take advantage of the distribution to gain the confidence of the family and community, and improve community sensitization necessary for the control of the epidemic.

### Beneficiary Population

The ultimate goal is to assist the entire population at high risk of contracting FHF. However, priority is given to the following:

- Admitted or deceased FHF patients currently in the FHF ward of the hospital.
- Admitted or deceased FHF patients detected retrospectively.
- Medical staff of the hospital.

### Methodology

Once the list of persons to be assisted has been decided upon, the following should be done:

1. Follow up of contacts immediately following discharge or death of the victim.
2. Delivery of the humanitarian kit to the family.
3. Evaluation of the family grieving process.
4. Psychological support in the grieving process if required.

If the family agrees, psychological follow up can be done over a maximum period of three weeks, with the intention of evaluating possible psychological sequels due to the events that have occurred.

### Measures of Success

- The family accepts the MSF team in their home.
- Information is provided by the family about possible warning signs in other family members.
- Atmosphere of confidence regarding feelings related to FHF.
- The transfer of other possible cases within the family to the treatment unit is facilitated.

### Contents of the Solidarity Kit

Suggested contents of the components of the kit are given below; the contents and the numbers of items in the kit should be adapted to the context. The kit for discharged patients and for the relatives of deceased patients can differ slightly, e.g. clothes can be given to the discharged patients.

#### Example of items that can be provided in a Solidarity Kit:

Quantity	Item
1	Mattress or mat
1	Mosquito net
2	Sheets
1	Blanket
4	Towels
4	Soap for personal hygiene
4	Bars of soap for laundry
	Clothing (for discharged patients)

## Annex 20. Supplies for Rumor Checking Team

The following items must be carried in the vehicle. Verify the presence of all items listed in the following checklist before starting work.

<b>Item</b>	<b>Quantity per person (take spare items for 1 person with you)</b>
<b>Protective Equipment</b>	
Plastic aprons	1
Goggles	1
Overalls	1
Head covers	1
Masks	1
Examination gloves (box at least half full)	1 pair
Rubber cleaning gloves	1 pair
<b>Other equipment</b>	
	<b>Total quantity for the team</b>
10-litre spraying machine filled with 0.5% chlorine solution	1
1-litre hand-sprayer filled with 0.05% chlorine solution	1
Plastic sheeting 3m-3m	1
Thermometer	2
Plastic rubbish bags	4
Hand soap	1 bar
HTH granules and 1 measuring spoon	1 kg
Bucket with lid to hold re-usable protective items after use	1
Guideline for preparing chlorine solutions	1
MSF tape	1 roll
<b>Medication</b>	
Anti-malarial: Coartem, oral quinine (pregnant ladies), etc.	
Oral antibiotics: Ciprofloxacin, amoxicillin, etc.	
Paracetamol: adults and children	
Oral Rehydration Solution	

**All these items must be replaced immediately after use. The equipment must always be ready to use.**

## Annex 21. Supplies for Ambulance Team

The following items must be carried in the vehicle. Verify the presence of all items listed in the following checklist before starting work.

<b>Item</b>	<b>Quantity per person (take spare items for 1 person with you)</b>
<b>Protective Equipment</b>	
Plastic aprons	1
Goggles	1
Overalls	1
Head covers	1
Masks	1
Examination gloves (box at least half full)	1 pair
Cleaning gloves	1 pair
<b>Other equipment</b>	
	<b>Total quantity for the team</b>
10-litre spraying machine filled with 0.5% chlorine solution	1 - 2
1-litre hand-sprayer filled with 0.05% chlorine solution	1
Plastic sheeting 3m-3m	1
Vinyl stretcher	1
Plastic covered mattress	1
Thermometer	1
Plastic rubbish bags	4
Hand soap	1 bar
HTH granules and 1 measuring spoon	1 kg
Plastic cup	1
10-litre jerry can filled with 10 liters of water for making additional 0.5% chlorine solution	1
Bucket with lid to hold re-usable protective items after use	1
Yellow bucket with lid for emergency waste receptacle for patient en route	1
Absorbent pads	3
Patient transport guideline	1
Guideline for preparing chlorine solutions	1
MSF tape	1 roll

**All these items must be replaced immediately after use. The equipment must always be ready to use.**

## Annex 22. Supplies for Spraying Teams

The following items must be carried in the vehicle. Verify the presence of all items listed in the following checklist before starting work.

<b>Item</b>	<b>Quantity per person (take spare items for 1 person with you)</b>
<b>Protective Equipment</b>	
Plastic aprons	1
Goggles	1
Overalls	1
Head covers	1
Masks	1
Examination gloves (take a box at least half full)	1 pair
Rubber cleaning gloves	1 pair
<b>Other equipment</b>	
	<b>Total quantity for the team</b>
10-litre spraying machine filled with 0.5% chlorine solution	1
1-litre hand-sprayer filled with 0.05% chlorine solution	1
Plastic rubbish bags	4
HTH granules and 1 measuring spoon	1 kg
Plastic cup	1
10-litre jerry can filled with 10 liters of water for preparing 0.05% or additional 0.5% chlorine solution.	1
Bucket with lid to hold re-usable protective items after use	1
Plastic sheeting 3m –3m	1
Guideline for preparing chlorine solutions	1
MSF tape	1 roll

**All these items must be replaced immediately after use. The equipment must always be ready to use.**

## Annex 23. Supplies for Burial Teams

The following items must be carried in the vehicle. Verify the presence of all items listed in the following checklist before starting work.

Item	Quantity per person (take spare items for 1 person with you)
<b>Protective Equipment</b>	
Plastic aprons	1
Goggles	1
Overalls	1
Head covers	1
Masks	1
Examination gloves (box at least half full)	1 pair
Latex protection gloves	1 pair
<b>Other equipment</b>	
	<b>Total quantity for the team</b>
10-litre spraying machine filled with 0.5% chlorine solution	1
1-litre hand-sprayer filled with 0.05% chlorine solution	1
Vinyl stretcher	1
Rope cut to 5-meter lengths	3 pieces
Rope cut to 15-meter lengths	1 piece
Plastic rubbish bags	4
HTH granules and 1 measuring spoon	1 kg
Plastic cup	1
10-litre jerry can filled with 10 liters of water for making additional 0.5% chlorine solution	1
Bucket with lid to hold re-usable protective items after use	1
Plastic sheeting 3m –3m	1
Burial guideline	1
Guideline for preparing chlorine solutions	1
MSF tape	1 roll
Forms for recording details of burial, grave location, etc.	1

**All these items must be replaced immediately after use. The equipment must always be ready to use.**

**Although most burial procedures can be performed without PPE, it is advisable to always take the PPE with you in case the situation might be different than expected or might change.**

## **Annex 24. Procedure to clean Marburg/Ebola unit after a death**

### **Objective**

- The Marburg/Ebola ward is made safe, disinfected, and cleaned, following the death of a patient.
- All activities are carried out in a safe way for staff, attendants, and other patients.

### **Procedure**

1. Following a death of a patient, the nurse in charge covers the body with a blanket.
2. The nurses put a screen around the bed of the deceased patient and call the burial team to enter the High-risk area.
3. Mobile patients in the ward should leave the ward temporary.
4. 2-3 people from the burial team and 2-3 people from the cleaning team enter in full protective clothing.
5. Body, blanket and clothes will be sprayed with 0.5% chlorine solution.
6. Write the name of the deceased person on the outside of the body bag with a waterproof marker.
7. Spray the body bag inside.
8. The body will be wrapped in the blanket and placed with personal clothing in the body bag.
9. Spray again inside the body bag, close the body bag securely (zip closed to the face of the patient) and spray outside the body bag.
10. Place body bag on stretcher and transport body to the mortuary in the Marburg/Ebola unit.
11. Cleaners remove the mattress for spraying with 0.5% chlorine solution and dry in the sun or burn in case of heavy contamination.
  - a. Dirty mattress can be folded and tied with some strings or cloths.
12. All remaining clothes and blankets are put in a plastic bag.
13. Mattress and bags are sprayed with 0.5% solution before transport.
14. Inform the waste burner that the material must be burned.
15. Cleaners collect all material used by the patient.
16. All plastic cups, cutlery, plates; buckets are washed with 0.05% solution and can be reused by other patients or can be burned.
17. The bed, window, walls, and the whole floor are disinfected with 0.5% chlorine solution by pouring with a cup or by spraying.
18. Put new/clean mattress on the bed.
19. Remove screen from the bed.
20. Cleaners remove all cleaning material.
21. When leaving cleaners and the burial team members thoroughly disinfect aprons, boots, and gloved hands with 0.5% chlorine solution.
22. Inform the Nurse in Charge that the ward has been cleaned.

## Annex 25. Procedure for house disinfection

House disinfection must be carried out in a sensitive manner. The process results in the destruction of some of the family's belongings, and damage to other items may also occur. Clearly explain the procedure to the family, and obtain their agreement. Explain that a Solidarity Kit will be provided to replace the items destroyed.

### Objective

- Contaminated items and the area where the patient was accommodated are made safe and disinfected, following the death or transfer of a patient.
- All activities are carried out in a safe way.

### People Participating

- One family member (if they want): he/she must be dressed in full protective clothing
- Disinfection team: supervisor, 2 sprayers.

### People dressing up

Maximum 4 people will need to dress up and full PPE material should be taken for 5 people: 2 sprayers, 1 supervisor, 1 family member and 1 extra PPE should always be taken.

### Procedure

1. After the patient has left the room, the supervisor enters and assesses the area. If the sprayers are experienced, the supervisor will not need to dress up and can supervise from outside the house.
2. The 2 sprayers need to be dressed in PPE and should take 1 spraying machine.
3. One spraying person should spray everything and the other person should pick up the clothes, blankets and mattress that need to be sprayed and put it outside to be sprayed.
4. A family member may participate if wanted, and need to be fully dressed.
5. Disinfect by spraying **0.5% chlorine solution**:
  - General area where the patient was accommodated during his sickness.
  - Reusable hard items, such as buckets, furniture, etc. and after the spraying the family can clean the items with soap and water.
  - Bed, windows, walls and the whole floor.
  - Latrine.
  - Mattress and let dry in the sun. (If not too contaminated.)
6. Disinfect by spraying **0.05% chlorine solution** (solution to be prepared on the spot in a basin or bucket provided by family):
  - Bedding and clothing (but if very dirty need to be burned!); after disinfection it can be washed with water and soap and then dried in the sun by the family members.
  - Eating utensils like plates, spoons, cups; after disinfection it can be cleaned with water and soap by the family members.
7. In case of heavy contamination:
  - Remove mattress, bedding, and clothing for burning.
  - Dirty mattress can be folded and tied with some strings or cloths.
  - Material to be burnt should be bagged or wrapped in plastic sheeting and transported to the waste zone at the Marburg/Ebola unit for disposal.
8. Backfill any waste pits that have been used.



## **Annex 26. Guideline for Safe Burial Practices**

The Water/Sanitation specialist will need to be updated with the latest consensus about burial procedures. Burial procedures need to be well explained to the community.

### **1. Burial procedure for patient dying in the Marburg/Ebola unit:**

#### **Tasks of Marburg/Ebola unit staff:**

- Transport of the body out of the mortuary and out of the Marburg/Ebola unit:

Staff dressed up in PPE from the Marburg/Ebola unit should:

- Walk to the morgue and put the prepared body in the body bag on a stretcher.
- Carry the stretcher outside the mortuary and the Marburg/Ebola unit via the special exit for corpses.
- The coffin should be placed at the special exit for corpses and the burial car/pick up should be parked close to it.
- Ask the family if they want to see the face of the deceased person. If they want to see it, open the body bag and show the face.
- Then close the body bag.

If a coffin is used:

- Spray the coffin inside with 0.5% chlorine solution.
- Put the body in the coffin, close securely and spray outside.

If no coffin is used:

- The body will need to be put in 2 body bags.
- The second body bag needs to be sprayed inside, then place the first body bag with the body inside the second body bag.
- Close the second body bag and spray the outside of the second body bag.

After the body is put in the coffin or second body bag:

- Spray the stretcher thoroughly.
- The Marburg/Ebola unit team will return dressed to the Marburg/Ebola ward and the Burial team will continue the safe burial procedures.

#### **Burial team:**

- Needs to consist of a minimum of 3 people and 1 supervisor (to lower a coffin you need to be minimum 4 persons)

#### **Tasks of the Burial team staff:**

- Transport of the body to the gravesite:

- The place where the Marburg/Ebola unit team walked outside the Marburg/Ebola unit should be sprayed with a 0.5% chlorine solution.
- Place coffin or the body in the 2 body bags at the back of the pick up and transport to gravesite.
- Burial team wears examination gloves.

- **Burial:**

- Place ropes on ground at two or three intervals (knee, lower back, upper back) to use to lower coffin into grave, and place coffin on top of the ropes. Latex protection gloves need to be used when lowering the coffin.
- 4-6 persons lower coffin using the ropes into the grave.
- Community members may help to lower the coffin and will fill the grave with earth.
- No PPE is required, only examination gloves and latex protection gloves when lowering the body.
- Back of the pick up needs to be sprayed with 0.5% chlorine solution.

### **Dressing during the burial**

When the body is put in 1 body bag and a coffin or 2 body bags and no coffin, for staff carrying the body it is possible only to be dressed in scrub suits, boots and put on examination gloves and latex protection gloves.

## **2. Procedure for Burial of Suspect/Probable/Confirmed Patient Dying at Home**

- Before giving protective materials, the supervisor of burial team should enter the family compound to speak with the responsible person in family.
- Explain the burial procedure and provide information on FHF transmission.
- Explain why the body must be buried safely and explain the procedure for disinfection of the body.
- Ensure coffin (if used) and grave is prepared (2 meters deep).
- Put on fully protective clothing (PPE). (Minimum 2 people.)
- Follow procedures for preparation of the body and the use of body bags and/or coffin.

### **Preparation of body**

- Spray the body and the area around body with 0.5% chlorine.
- Spray sheet and/or blanket thoroughly with chlorine solution.
- Wrap body in blanket and cover completely.
- Open body bag and place body and personal clothing inside.
- Close body bag securely.
- Spray outside of body bag with 0.5% chlorine.
- Put in coffin or second body bag as described before.
- After removing the body from the house, disinfect the room in which the patient died as well as the patient's mattress.
- Burn the mattress.
- Undress in front of the community. (If situation allows!)
- Put on examination gloves.
- Proceed to the gravesite, put latex protection gloves when carrying the coffin to the grave and lower the coffin/body in double bags as described before.
  
- A Solidarity Kit needs to be provided. See **Annex 19. Solidarity Kit**

## Annex 27. Treatment of facilities and equipment when closing the Marburg/Ebola unit.

Item	Treatment*	Remarks
Bed frames, stretchers and hard furniture	Disinfection by spraying with 0.5% solution and drying in the sun.	Destroy if impossible to disinfect
Mattress covers	Burn, or if in good condition disinfection by immersion in 0.5% solution	
Mattresses	Burn if suspicion of contamination	If visibly clean, immerse in 0.5% solution, dry in sunlight and reuse
Plastic materials	Disinfection by immersion or spraying with 0.5% solution	
Clothing – scrub suits etc.	Disinfection with 0.05% solution, and washing	Burn items that are damaged or very worn
Rubber boots	Disinfection by immersion in 0.5% solution	Burn items that are damaged or very worn
Aprons	Disinfection by immersion in 0.5% solution	Burn items that are damaged or very worn
Medical equipment	Disinfection with 0.5% solution	Destroy if impossible to disinfect (e.g. stethoscope, sphygmomanometer)
Fencing (plastic sheeting)	Disinfection by spraying with 0.5% solution	Burn if damaged
Tents	Disinfection by spraying with 0.5% solution and rinsing with clean water	
Laboratory equipment	Burn disposable and waste items	Lab operators will deal with their reusable equipment
Water bladders and plastic pipes	Outside Unit – disinfect, clean, and dry normally. Inside Unit – burn if risk of contamination	How to store bladders tech brief PHT
Tap-stands	Disinfect by immersion in 0.5% solution and dry in the sun	
Cleaning materials (brushes mops, etc.)	Burn	
Wards and buildings	Disinfection of surfaces and walls by spraying with 0.5% solution	
Flush toilets	Disinfection of all surfaces by spraying with 0.5% solution	
Pit latrines	Disinfection of all surfaces by spraying with 0.5% solution	If temporary latrines – disinfect, dismantle, burn superstructure & backfill pit
Bathrooms	Disinfection of all surfaces by spraying with 0.5% solution	Bathrooms – disinfect, dismantle, burn superstructure & backfill soakaways

Grease traps	Disinfection by filling with 0.5% chlorine solution	If temporary - backfill
Vehicles	Disinfection by spraying	Must be rinsed after disinfection
Sharps pit	Encapsulate contents with concrete slurry	If permanent construction – can continue to be used after partial encapsulation
Organics pit	Encapsulate with concrete slurry	If permanent construction – can continue to be used after partial encapsulation
Burning pit	Encapsulate with concrete slurry	If permanent construction – can continue to be used after partial encapsulation

*\*Any metallic items and items that will subsequently be in contact with the skin e.g. boots, mattress covers, should be rinsed with clean water once disinfected.*

## Annex 28. Suggested changes in the Filoviral Haemorrhagic Fever Kit

During previous outbreaks and use of the Viral Haemorrhagic Fever Kit, it is noticed that the some items of the Kit need to be replaced or need to be available in larger amounts. Other items need to be included.

### To be replaced:

#### **PPE**

- **Examination gloves:** Instead of the examination gloves, extra protection nitrile gloves, 300 mm, Bioclean 100 nitrile can provide better protection due it is length (higher up the arm)
- **Goggles:** Uvex Ultrasonic type 9302245 fits better.
- **Surgical caps:** not useful, use surgical hoods instead.
- **Aprons:** the latex aprons break easily and are heavy to wear

### To be ordered in larger quantities:

- **Anti fog spray:** bigger quantity is needed, high consumption.
- **Boots:** bigger quantity needed in the first phase of the outbreak with different and bigger sizes.
- **Foldable containers:** used in HBSRR: 10.
- **Hand sprayers:** bigger quantity is needed, e.g. 15. (Each car, each outreach team, etc.)
- **Spare parts of sprayer:** piston and rigid pipe.
- **Mirrors and clocks:** bigger quantity needed, but can be bought locally.
- **Surgical hoods:** bigger quantity is needed.
- **Water container 125 L** with PVC cap: bigger quantities.

### To be added to the Kit:

#### **Medical**

- **Azithromycin** 500 mg tablets and oral suspension 200 mg/5ml
- **Cefixime** 200 mg tablets and oral suspension 100 mg/5ml
- **Blood tubes:** EDTA tubes (anti-coagulation tube, with purple cover) and dry tubes (no anti-coagulation and with red cover) for sample taking: 50 each.  
The vacutainer equipment is not correct: the needle, sterile, 21G (ELAEBVV21N) does not fit into the holder for the vacuum tube (ELAEBVV1H)!! Impossible to take blood with this vacutainer equipment!!
- **Delivery set:** for deliveries in the Marburg/Ebola unit.
- **Non-digital thermometers:** digital thermometers are destroyed when disinfected with chlorine. Each admitted patient should receive it's own thermometer. Thermometers are used in contact follow up and rumor checking: 35.

#### **PPE:**

- **Face shields:** 9706514 Draggersafety for relatives: 50
- **Overshoes:** 200 (for relatives in Marburg/Ebola unit and in HBSRR and for caretakers accompanying patients during transport)
- **Single use scrub suits** at the first phase of the intervention: 500 (cleaning staff not yet trained, takes normally few days before the cleaning of clothes is done correctly)
- **Spare taps:** 125 l water container: 10

## LITERATURE

<sup>1</sup> Leroy EM, Kumulungui B, Pourrut X, Rouquet P, Hassanin A, Yaba P, Delicat A, Paweska JT, Gonzalez JP, Swanepoel R. Fruit bats as reservoirs of Ebola virus. *Nature* 2005 Dec 1;438(7068):575-6

<sup>2</sup> Jonathan S.Towner, Xavier Pourrut, Cesar G. Albarino, Chimene Nze Nkogue, Brian H.Bird, Gilda Grard, Thomas G. Ksiazek, Jean-Paul Gonzalez, Stuart T.Nichol, Eric M.Leroy. Marburg Virus infection detected in a common african bat. *PloSOneJournal Club*, 22 August 2007

<sup>3</sup> P.Roddy, D.Weatherill, B.Jeffs, Z.Abaakouk, C.Dorion, J.Rodriguez-Martinez, P.P. Palma, O.de la Rosa, L.Villa, I.Grovas, M.Borchert. The Medecins sans Frontieres intervention in the Marburg Hemorrhagic Fever epidemic, Uige, Angola 2005. II. Lessons learned in the community. *Journal of Infectious Diseases* 2007:196 (Suppl 2)

<sup>4</sup> B.Jeffs, P.Roddy, D.Weatherill, O.de la Rosa, C.Dorion, M.Iscla, I.Grovas, P.P. Palma, L.Villa, O.Bernal, J.Rodriguez-Martinez, B.Barcelo, D.Pou, and M.Borchert. The Medecins sans Frontieres intervention in the Marburg Hemorrhagic Fever epidemic, Uige, Angola 2005. I. Lessons learned in the Hospital. *Journal of Infectious Diseases* 2007:196 (Suppl 2)

<sup>5</sup> D.G.Bausch, A.G.Sprecher, B.Jeffs, P.Boumandouki. Treatment of Marburg and Ebola haemorrhagic fevers: A strategy for testing new drugs and vaccines under outbreak conditions. *Science Direct, Antiviral Research* 78 (2008) 150-161

## BIBLIOGRAPHY

- Ebola & Marburg Outbreak Control Guidance Manual, version 2.0, Peter Thomson, 2007
- Ebola Expatriate Health Recommendation, draft 7, MSF
- MSF Public Health Engineering in emergency situation, first edition 1994